

# PRODUCT SPECIFICATIONS ■

## Ruckus™ Seating

January 2020

### TECHNICAL SPECIFICATIONS

#### Description

Ruckus promotes student movement through its unique design. It's generously sized seating encourages an "as you like it" sitting experience. The chair back shape includes integral armrests, which are also engineered to function as a support surface.

#### Seat & Backrest

Both the seat and backrest shell are made of static-free high-impact polypropylene. Colorfastness is ensured through complete color impregnation throughout the molded part. Textured on both sides with a contrasting texture pattern on the seat. Ergonomic handle molded into the chair backrest for ease of mobility. Seat and backrest fasten to the frame with six  $\frac{1}{4}$ -20 x  $\frac{3}{4}$ " Hi-Lo screws.

#### Optional Upholstered Seat

Upholstered seats have partially exposed polypropylene surfaces. Molded urethane foam is attached to an injection-molded polypropylene liner board, then upholstered using a draw-string process and fastened to an inner shell with screws. Seat foam is molded nominal 1" thickness.

#### Frames

4-Leg, Stack, Stool and Task chair frames are constructed with 1" outside diameter 13-gauge steel tubing, welded to 13-gauge steel plates and  $\frac{1}{4}$ " wire. Frame is nickel-chrome plated or finished in powder-coat paint after all welding processes are complete.

#### Glides

Stack, Stool & 4-Leg Chairs - Swivel-type polished zinc-plated steel, nylon plastic, or felt glides. KI recommends consulting with the floor manufacturer for specific glide recommendations.

**Note:** Felt glides add  $\frac{1}{4}$ " to the overall height range.

Task Chair - Optional Bell glides (2" high) made of high impact plastic also available. Black only.

**Note:** Bell glides add  $\frac{1}{4}$ " to the overall height range.

#### Casters

Carpet Casters Option - 50 mm double wheels of high-impact thermoplastic. High-impact plastic frame. Black finish only. Hard Floor Casters Option - 50 mm double wheels of soft plastic.

High-impact plastic frame. Black finish only.

#### Task Chair

Pneumatic Height Adjustment - Lever-activated pneumatic cylinder enables seat-height adjustment from 16 $\frac{1}{2}$ " to 21 $\frac{1}{4}$ ". Five-blade base - 28" injection molded, 30% fiberglass reinforced nylon 5-blade base. Available in Black or Warm Gray.

#### Bookbag Rack

Stack Chair Frame - Optional bookbag rack is a welded framework of  $\frac{1}{4}$ " diameter solid wire welded to eight  $\frac{1}{8}$ " thick plates. Fastened to stackable chair frame with eight #10 screws. Bookbag rack will be nickel-chrome plated or finished in powder-coat paint after all welding processes are complete.

#### Compliance

Ruckus chair components originate from ISO 9000, ISO 9001 or ISO 9002 registered facilities.

Ruckus seating is designed and manufactured to meet or exceed required ANSI/BIFMA X5.1-2011 Seating.



## DIMENSIONS

General Dimension			
Seat Height	A (Seat Depth 1)	B (Seat Width)	C (Seat Depth 2)
15"	18.8"	22.3"	16.7"
18"	18.8"	22.3"	16.7"

Chair Overall Dimension							
Seat Height	D (Width 1)	E (Width 2)	F (Depth 1)	G (Depth 2)	H (Height)	I (Seat Height)	J (Backrest Height)
15"	22.8"	28"	22.8"	29"	25.5"	15"	10.4"
15" (Upholstered Seat)	22.8"	28"	22.8"	29"	25.5"	16.3"	10.4"
18"	22.8"	28"	22.8"	29"	29.5"	18"	11.4"
18" (Upholstered Seat)	22.8"	28"	22.8"	29"	29.5"	19.3"	11.4"
24" Stool	22.8"	28"	22.8"	29"	35.5"	24"	11.4"
24" Stool (Upholstered Seat)	22.8"	28"	22.8"	29"	35.5"	25.3"	11.4"
30" Stool	22.8"	28"	22.8"	29"	41.5"	30"	11.4"
30" Stool (Upholstered Seat)	22.8"	28"	22.8"	29"	41.5"	31.3"	11.4"
Task Chair	22.8"	28.25"	22.8"	27.67"	28"-32.75"	16.5"-21.25"	11.4"
Task Chair (Upholstered Seat)	22.8"	28.25"	22.8"	27.67"	28"-32.75"	17.7"-22.4"	11.4"

**Note:** Dimensions are consistent for both 4-Leg & Stack Chair options.

**Note:** Felt and Bell glides add 1/4" to the overall height range.

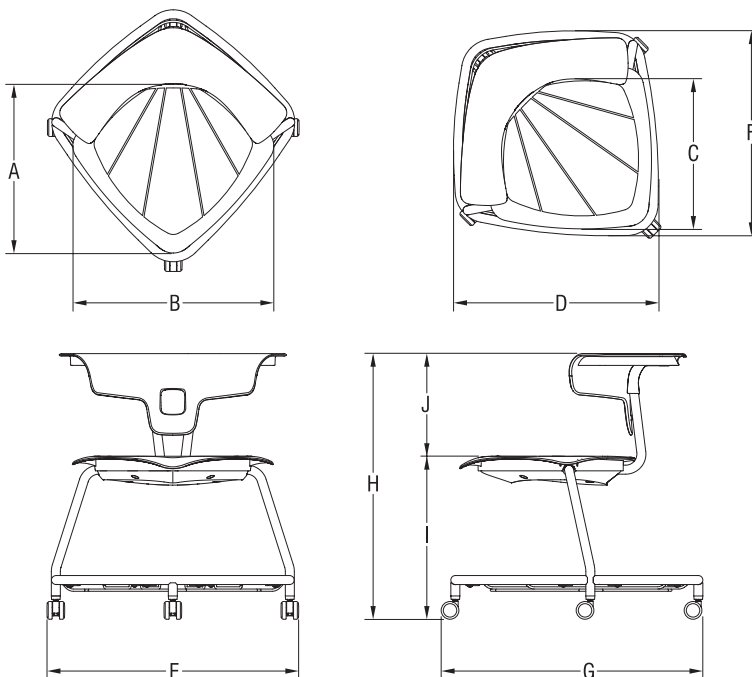

## CODE COMPLIANCE



STATEMENT OF LINE

Ruckus Task Chairs



RK5100



RK5200

Ruckus 4-Leg Chairs

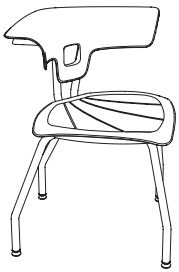

RK1100H18-NB

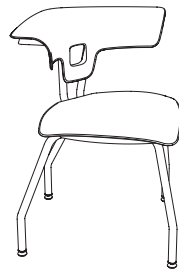

RK1200H18-NB

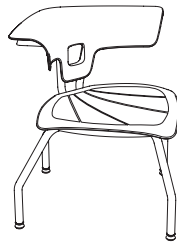

RK1100H15-NB



RK1200H15-NB

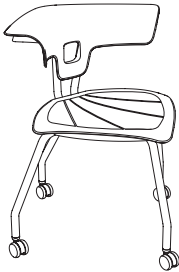

RK2100H18-NB

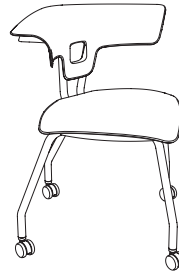

RK2200H18-NB

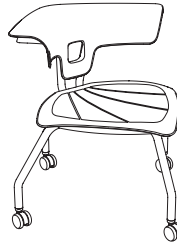

RK2100H15-NB

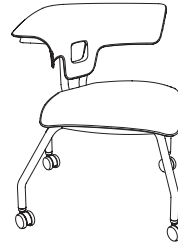

RK2200H15-NB

CODE COMPLIANCE



STATEMENT OF LINE

Ruckus Stack Chairs

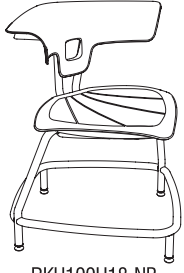

RKU100H18-NB

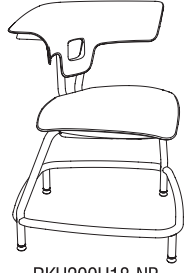

RKU200H18-NB

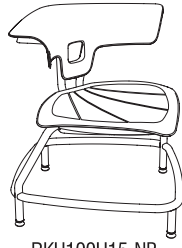

RKU100H15-NB

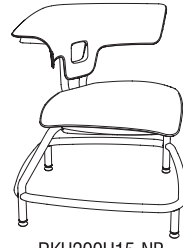

RKU200H15-NB

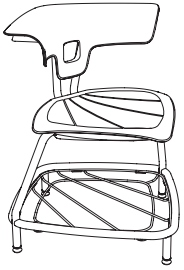

RKU100H18-BR

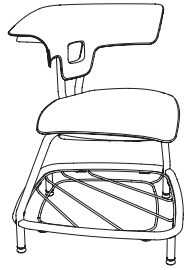

RKU200H18-BR

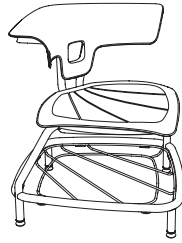

RKU100H15-BR

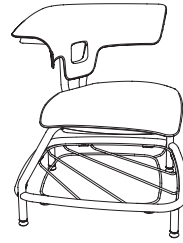

RKU200H15-BR

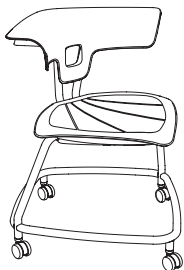

RKV100H18-NB

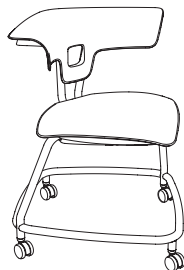

RKV200H18-NB

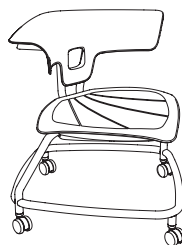

RKV100H15-NB

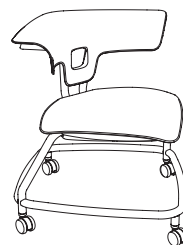

RKV200H15-NB

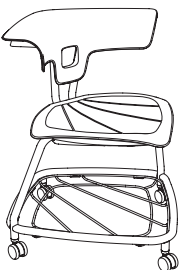

RKV100H18-BR

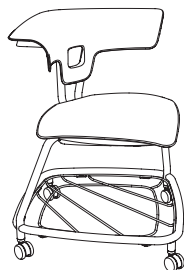

RKV200H18-BR

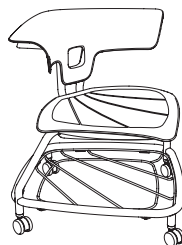

RKV100H15-BR

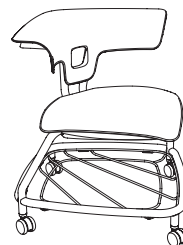

RKV200H15-BR

CODE COMPLIANCE



STATEMENT OF LINE

Ruckus Stools

CODE COMPLIANCE

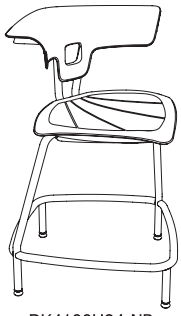

RK4100H24-NB

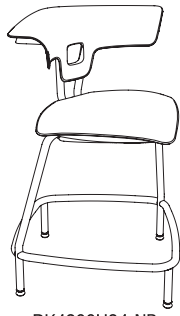

RK4200H24-NB

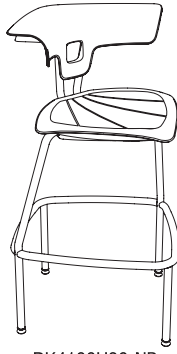

RK4100H30-NB

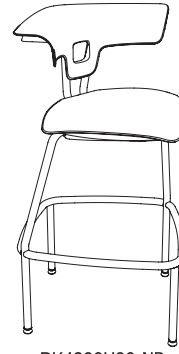

RK4200H30-NB

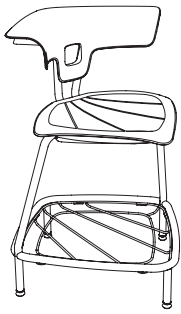

RK4100H24-BR

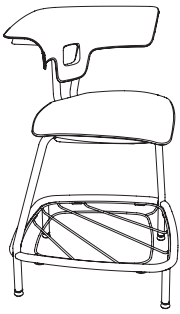

RK4200H24-BR

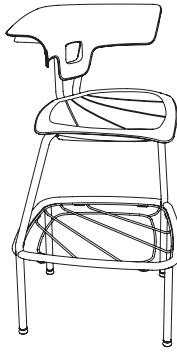

RK4100H30-BR

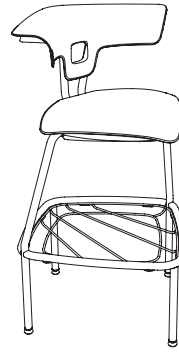

RK4200H30-BR

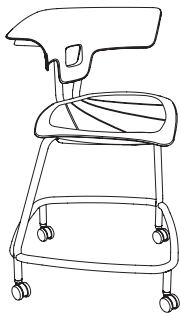

RKN100H24-NB

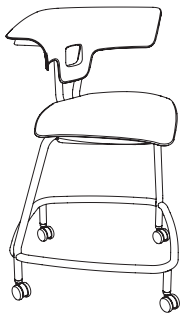

RKN200H24-NB

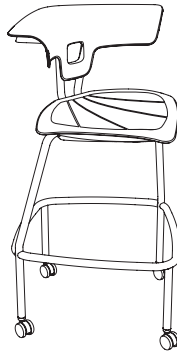

RKN100H30-NB

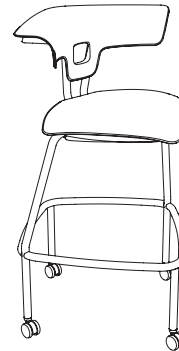

RKN200H30-NB

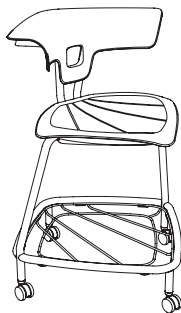

RKN100H24-BR

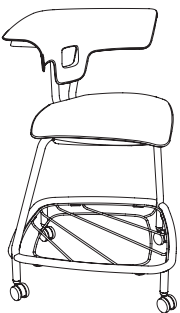

RKN200H24-BR

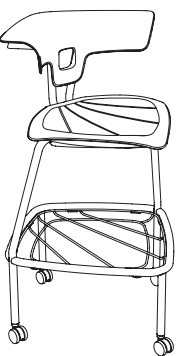

RKN100H30-BR

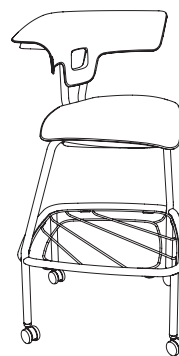

RKN200H30-BR