

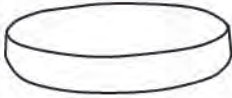

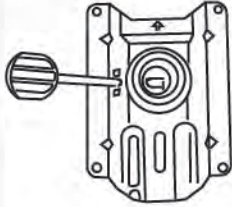



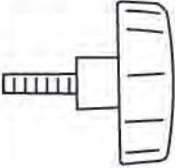

**IMPORTANT NOTICE:  
HARDWARE PACKAGE IS ATTACHED  
ON THE BOTTOM OF SEAT CUSHION.**

MODEL: 16245

(1)x1  Seat Cushion	(2)x1  TU001-305/Mechanism	(3)x1  Back Cushion W/ Back Support & Bellow
(4)x1  TU305-Knob/Knob	(5)x1  TU026-240/5 / Gas Lift	(6)x1  TU005-240/5 / Base
(7)x1  TU009	(8)x1  TU009-EXT	(9)x5  TU015 / Casters
(A)x4  M8X22 MECHANISM SCREW		

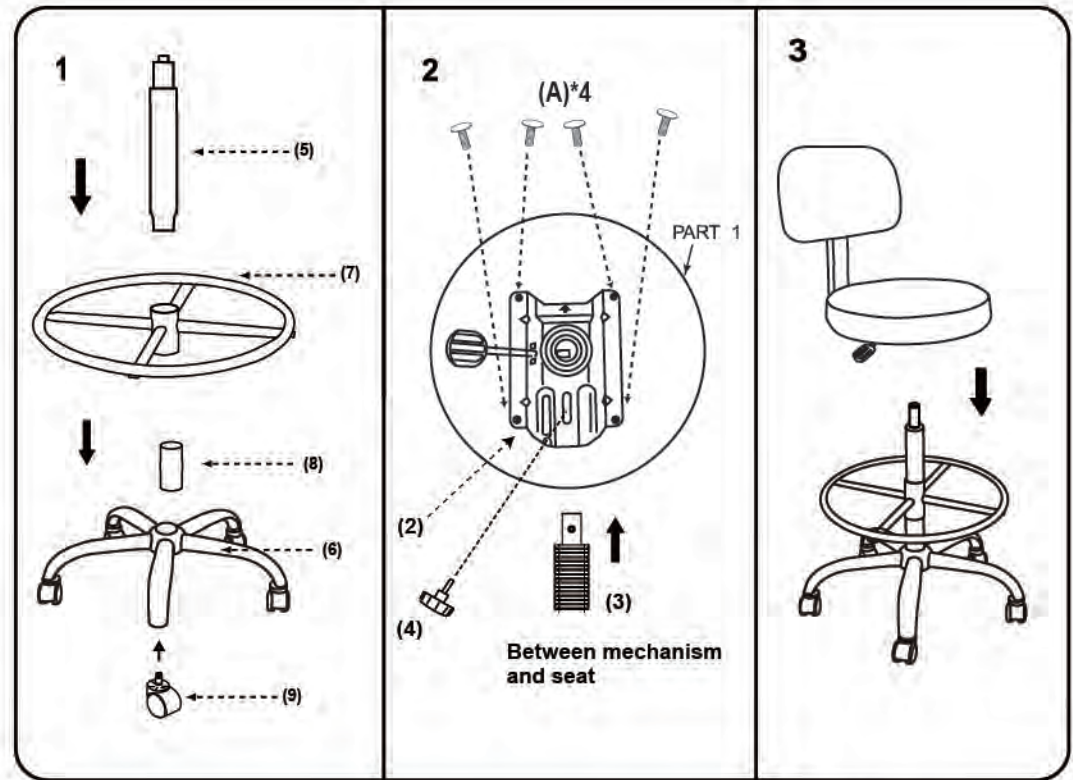

**Insert and loosely tighten all screws. When assembly is completed, fully tighten all screws before using. This chair is only intended for sitting. Any other use will void the warranty.**

