

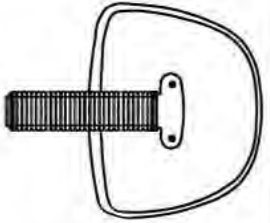





<p>(1)x1</p>  <p>Back Cushion Back Support W/ Bellow</p> <p>(4)x 1</p>	<p>(2)x1</p>  <p>Seat Cushion</p> <p>(5)x1</p>	<p>(3)x1</p>  <p>TU001-305 / mechanism</p> <p>(6)X1(L) X1(R)</p>
<p>TU005-25 – Nylon Base</p>  <p>(7)X1</p>	<p>TU026-305-Gas Lift</p>  <p>(8)X5</p>	<p>B316 / B317 Arms</p> 
<p>TU305-Knob/Knob</p> 	<p>TU015-Casters</p> 	
<p>(A)*4 M8*22 Mechanism Screws</p> <p>(B)*6 M6*28 Arm screws for B306, B316, B307, B317</p>		

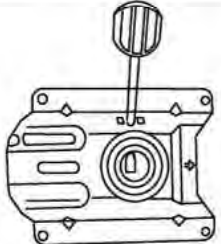

Insert and loosely tighten all screws. When assembly is completed, fully tighten all screws before using. This chair is only intended for sitting. Any other use will void the warranty.

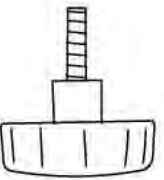
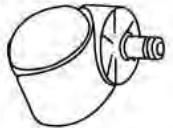
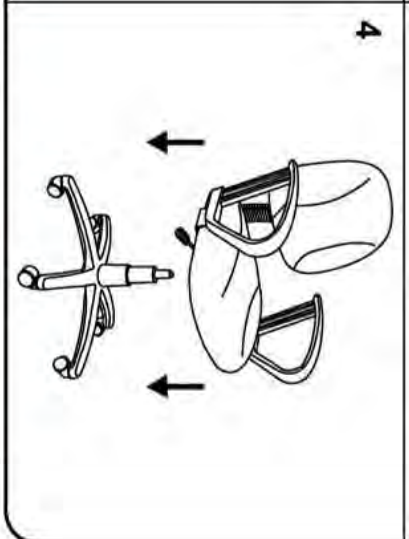
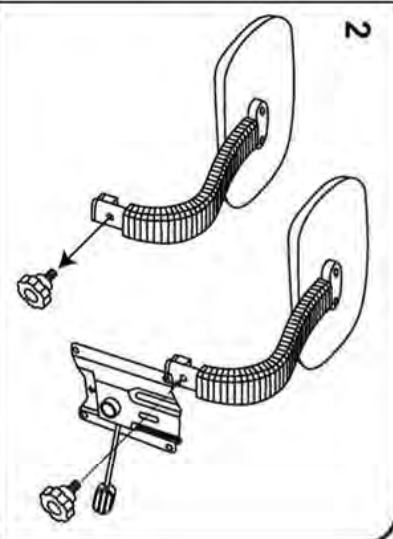
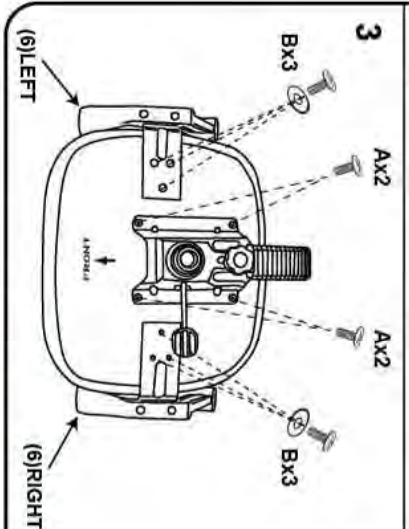
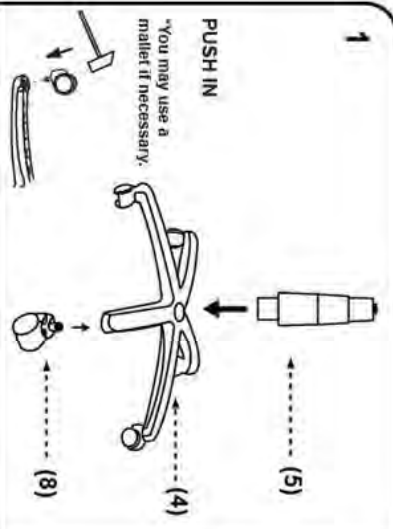