

Hallowell[®] Bulk Rack

ASSEMBLY INSTRUCTIONS

General Instructions

1. Check material received against the packing list. Check the number of packages received and then check the contents of each package.
2. Check the material received for damage. If damage has occurred, secure a “damage notation” from the carrier
3. Identify each part as it is unpacked and put like parts together as close as possible to the working area where they are to be assembled.
4. Be careful to use the correct hardware as specified in the assembly instructions.

CAUTION

In the interest of safety, all shelving/rack must be securely anchored to the floor and/or wall. For safety, handle all components carefully and wear work gloves when assembling. Install all units plumb and tighten all hardware securely. Retain instructions for future reference.



866-566-0500
info@Hallowell-List.com
www.Hallowell-List.com

STARTER UNIT

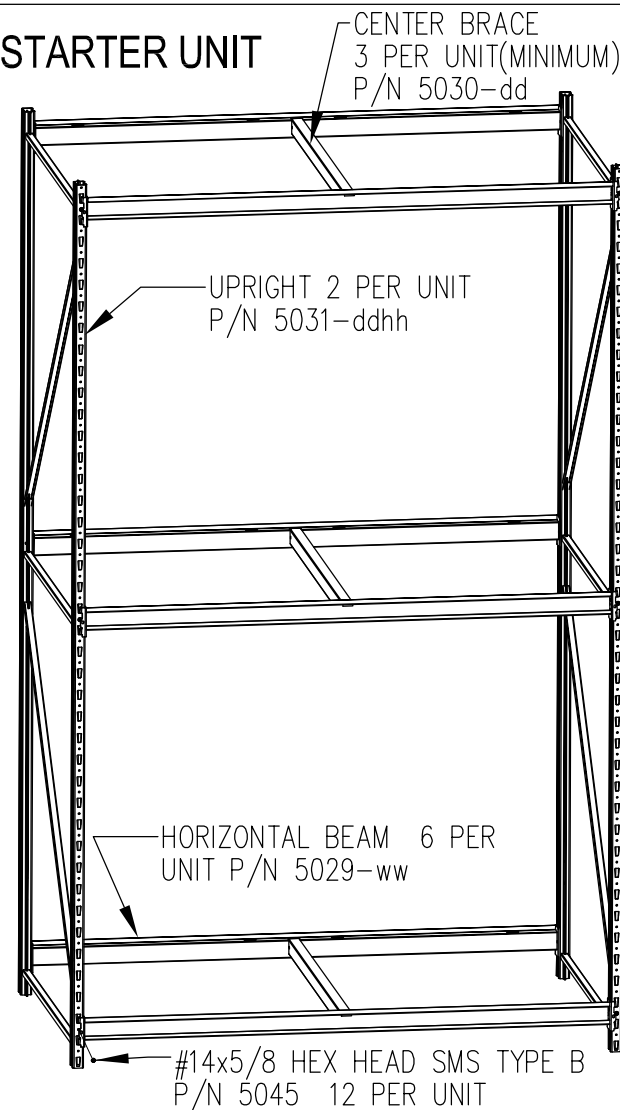

ADDER UNIT

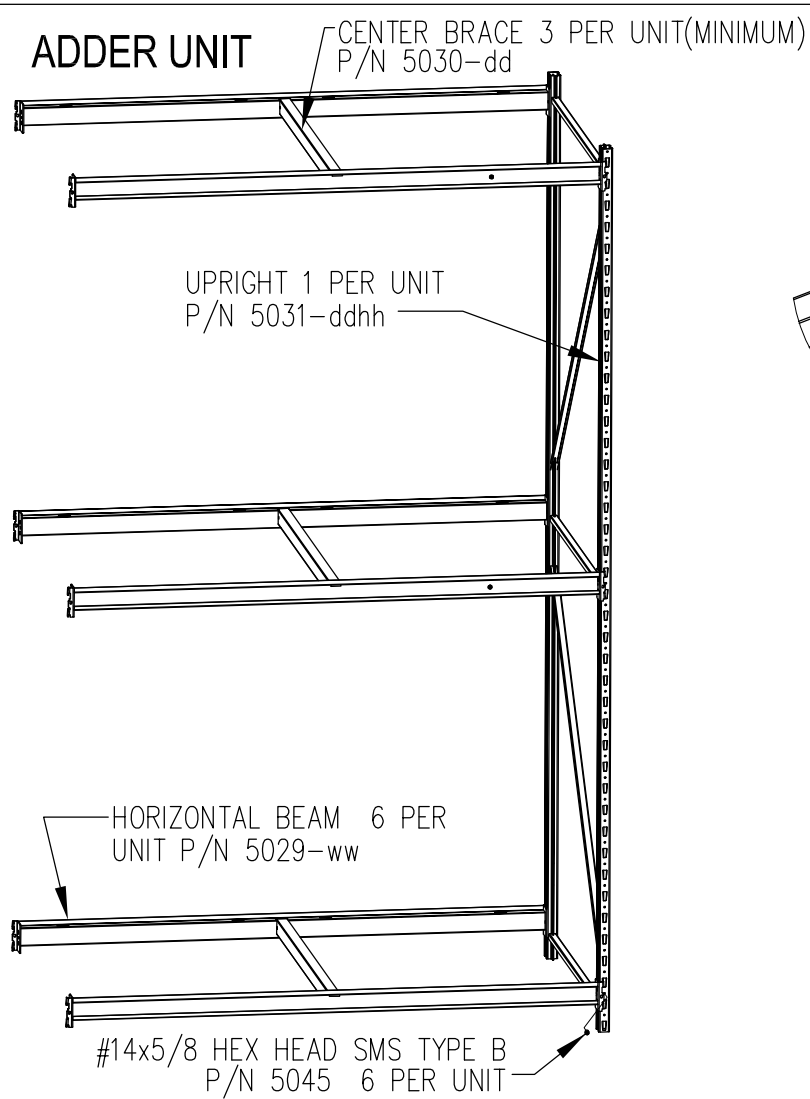

REVISIONS				
ECO	REV	DESCRIPTION	DATE	BY

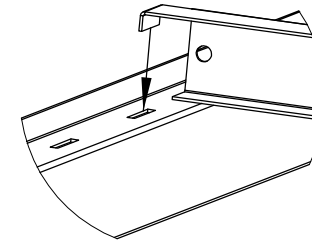

STEP3. INSERT CENTER BRACE TAB IN SLOTS IN HORIZONTAL BEAM. SEE BELOW FOR LOCATION AND QUANTITY OF SUPPORTS NEED FOR THE REQUIRED DECKING.

STEP4. INSERT DECKING AS REQUIRED.

FRONT TO BACK BRACE LOCATIONS

FOR 48" & 60" WIDE WITHOUT DECK, WITH WIRE DECK AND WITH STEEL SHELF DECK

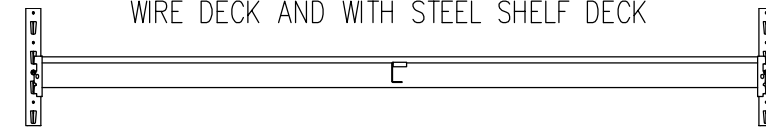

FOR 48" & 60" WIDE WITH PARTICLEBOARD DECK AND 72" & 96" WIDE WITHOUT DECK, WITH WIRE DECK AND WITH STEEL SHELF DECK



FOR 72" WIDE WITH PARTICLE BOARD

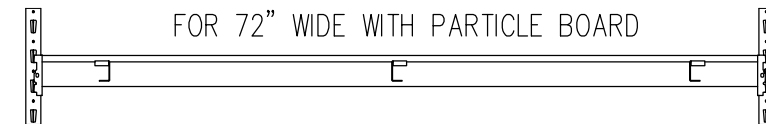

FOR 96" WIDE WITH PARTICLE BOARD

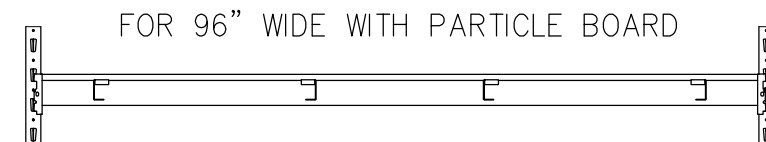

STEP1. WITH UPRIGHTS VERTICAL, INSERT HORIZONTAL BEAM END INTO KEY SLOT IN H-POST. INSERT ADDITIONAL BEAMS REQUIRED TO COMPLETE UNITS (STARTER AND ADDER).

STEP2. INSERT #14x5/8 SCREW IN HOLE IN H-POST TO LOCK HORIZONTAL BEAMS IN PLACE.

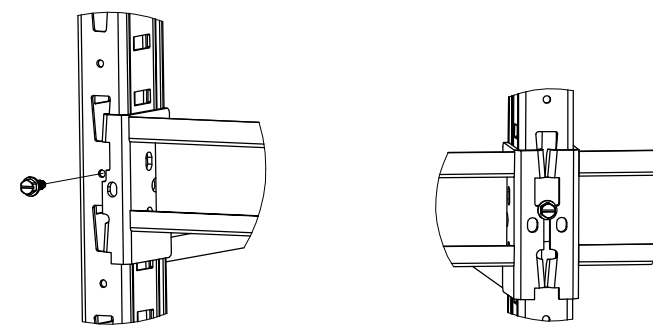

KEY SLOT IN H-POST

THIS DRAWING AND THE INFORMATION ON IT IS THE CONFIDENTIAL PROPERTY OF HALLOWELL, AND SHALL NOT BE COPIED OR DISCLOSED TO OTHERS WITHOUT WRITTEN PERMISSION. ONLY HALLOWELL RESERVES THE RIGHT TO ALTER ANY DESIGN. ANY UNAUTHORIZED MODIFICATIONS RELEASES HALLOWELL FROM ALL LIABILITIES.

TOLERANCES UNLESS OTHERWISE SPECIFIED

INCHES
XX. ± .010
XXX. ± .005

FRACTIONAL
X/X. ± 1/64

ANGULAR
∠ ± 1/2°

UNLESS OTHERWISE SPECIFIED ALL DIMENSIONS ARE IN INCHES. METRIC DIMENSIONS WILL BE WITHIN [XX]



www.Hallowell-List.com

2823 W. ORANGE AVE.
APOPKA, FLORIDA 32703

Tel (866) 566-0500
Fax (407) 464-3610

DRAWN BY	DATE	DESCRIPTION	SCALE	SHEET	PART NO.	DRAWING NO.	REV.
ROW	11/6/14	BULK RACK ASSEMBLY INSTRUCTION					
CHECKED BY	DATE						
APPROVED BY	DATE						
			1 OF 1	HBRwwddhh	SA1669		

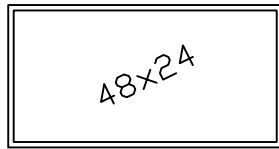

48x24

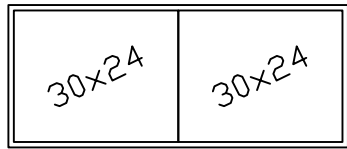

60x24

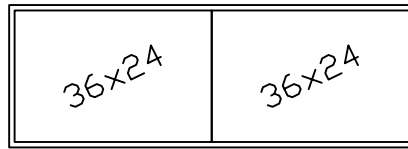

72x24

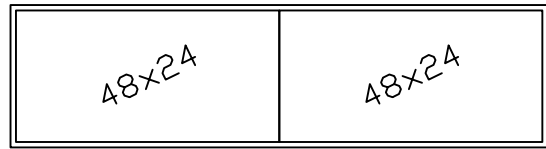

96x24

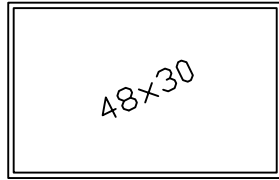

48x30

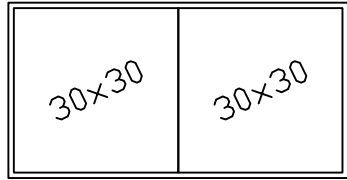

60x30

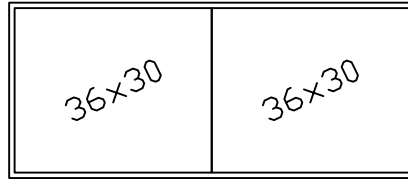

72x30

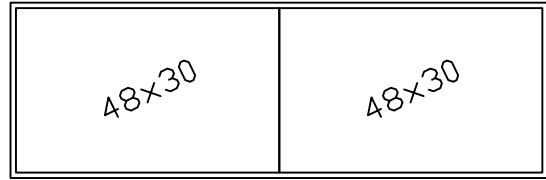

96x30

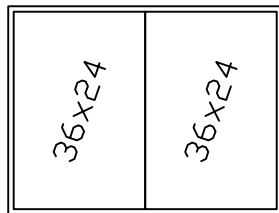

48x36

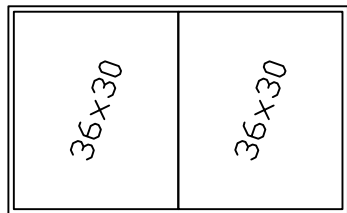

60x36

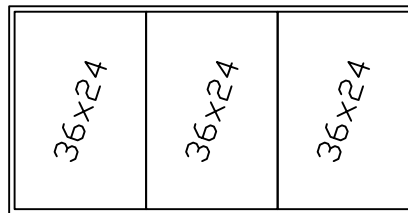

72x36

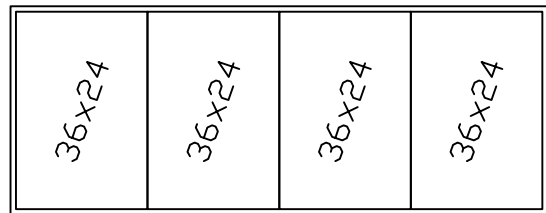

96x36

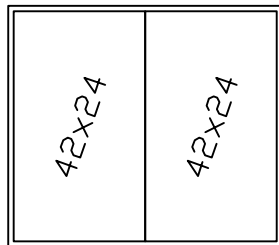

48x42

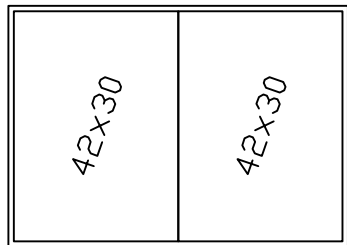

60x42

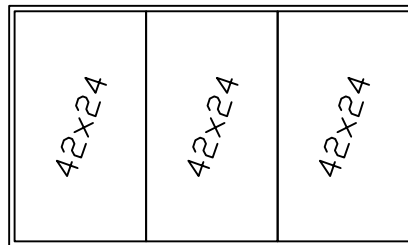

72x42

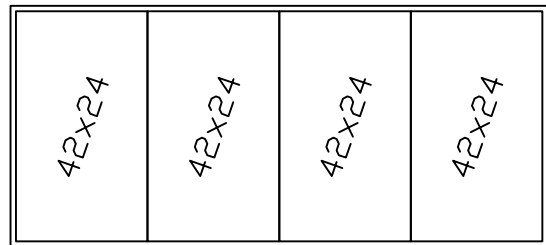

96x42

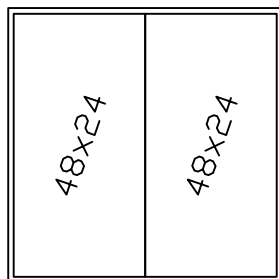

48x48

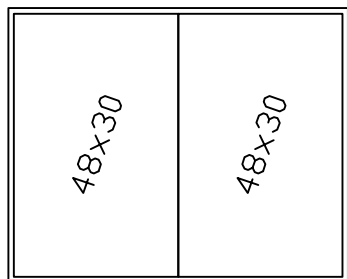

60x48

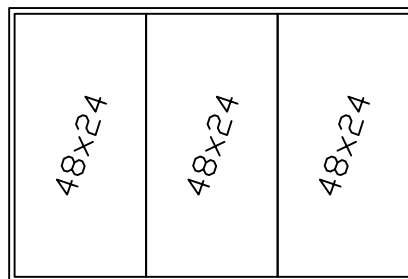

72x48

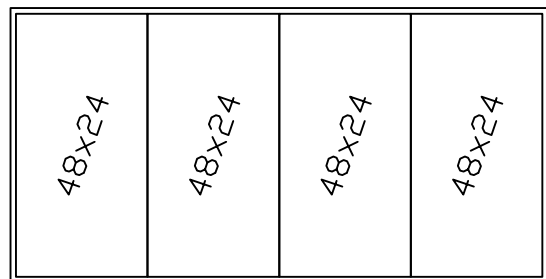

96x48

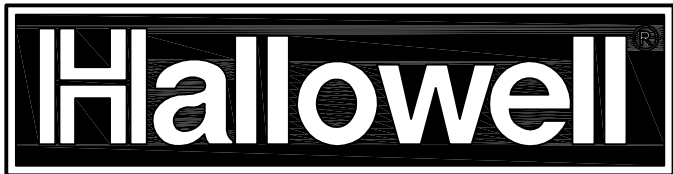

BULK RACK STEEL SHELF DECK PLACEMENT CHART