

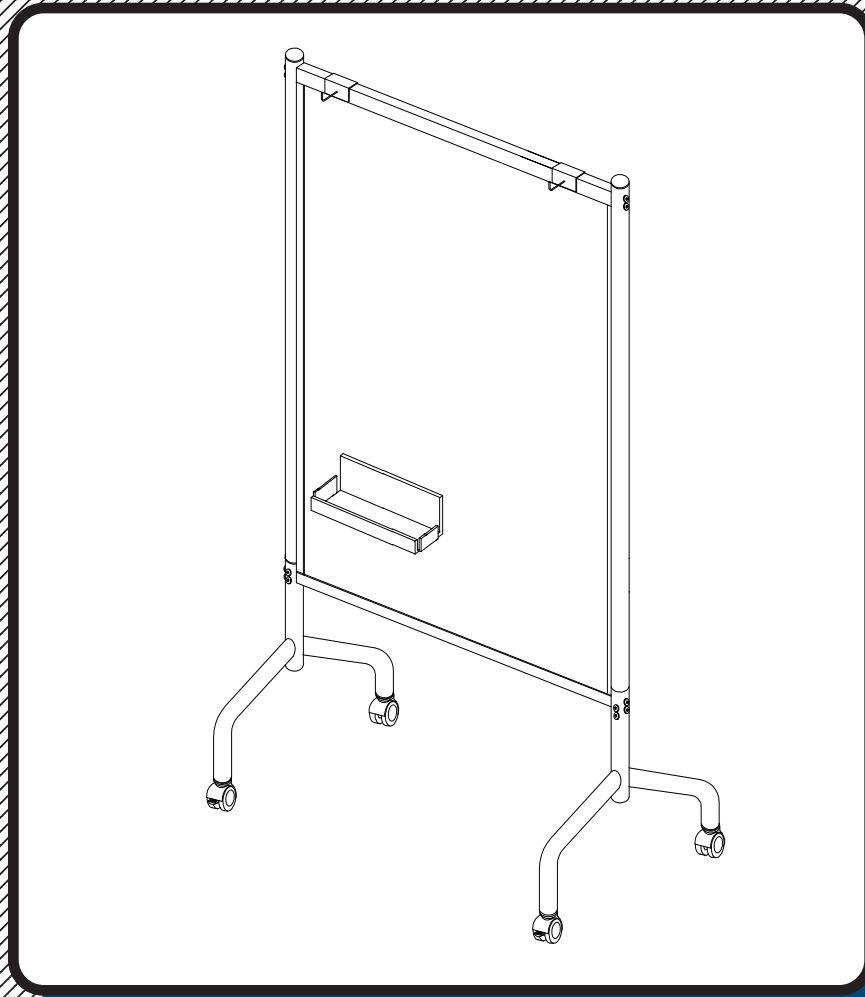

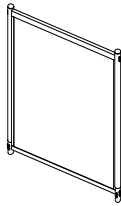













62542, 62544 Essential Mobile Magnetic Whiteboard



Assembly Instructions

Essential Mobile Whiteboard

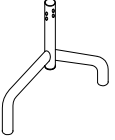
Part	Drawing	Description	Qty	Part	Drawing	Description	Qty																				
P1		Panel Assembly	1 EA	<div style="border: 2px solid black; border-radius: 15px; padding: 10px;"> <p style="text-align: center; margin: 0;">Hardware List</p> <table style="width: 100%; border-collapse: collapse;"> <tr> <td style="width: 5%; text-align: center;">A</td> <td style="width: 15%;"></td> <td style="width: 60%;">Locking Caster</td> <td style="width: 20%; text-align: right;">2 EA</td> </tr> <tr> <td style="text-align: center;">B</td> <td></td> <td>Caster</td> <td style="text-align: right;">2 EA</td> </tr> <tr> <td style="text-align: center;">C</td> <td></td> <td>Chart Hook</td> <td style="text-align: right;">2 EA</td> </tr> <tr> <td style="text-align: center;">D</td> <td></td> <td>Allen Wrench</td> <td style="text-align: right;">1 EA</td> </tr> <tr> <td style="text-align: center;">E</td> <td></td> <td>Tray</td> <td style="text-align: right;">1 EA</td> </tr> </table> </div>				A		Locking Caster	2 EA	B		Caster	2 EA	C		Chart Hook	2 EA	D		Allen Wrench	1 EA	E		Tray	1 EA
A		Locking Caster	2 EA																								
B		Caster	2 EA																								
C		Chart Hook	2 EA																								
D		Allen Wrench	1 EA																								
E		Tray	1 EA																								
P2		Foot	2 EA																								

Do not use unless all screws are tight. At least every six months, check all screws to be sure they are tight. If parts are missing, broken, damaged, or worn, stop use of the product until repairs are made by your dealer using factory authorized parts.

Assembly Diagram

READ THROUGH INSTRUCTIONS FROM BEGINNING TO END BEFORE STARTING TO ASSEMBLE UNIT.

- 1.) Identify and Separate all the Parts and Hardware.
- 2.) On the Panel Assembly (P1), remove the eight Screws from the bottom tubes of the vertical posts as shown in illustration #1.

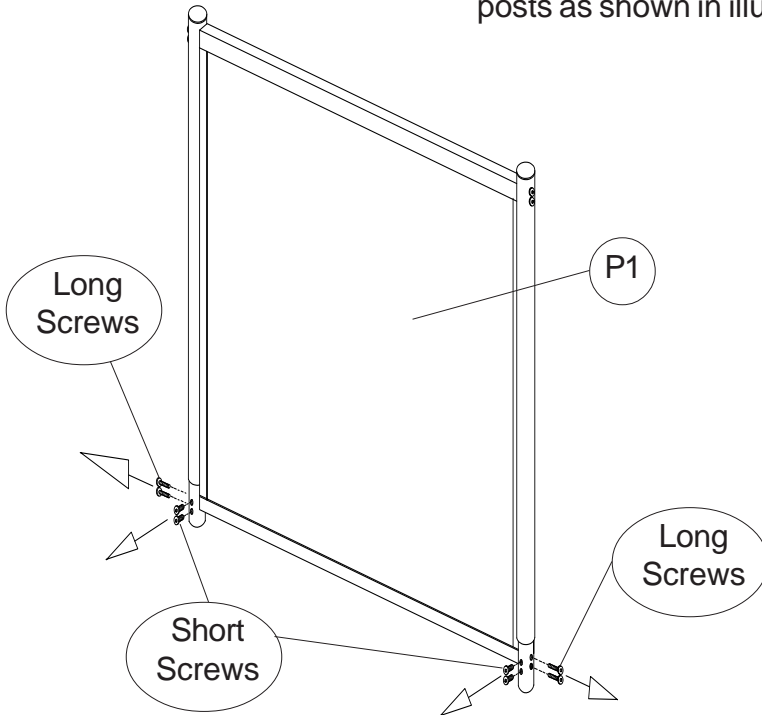

Illustration # 1

- 3.) Insert a Foot (P2) on the bottom of each vertical tube on the Panel Assembly (P1). Replace the Screws exactly as they were removed in Step 2. Use Allen Wrench (D) to tighten Screws.

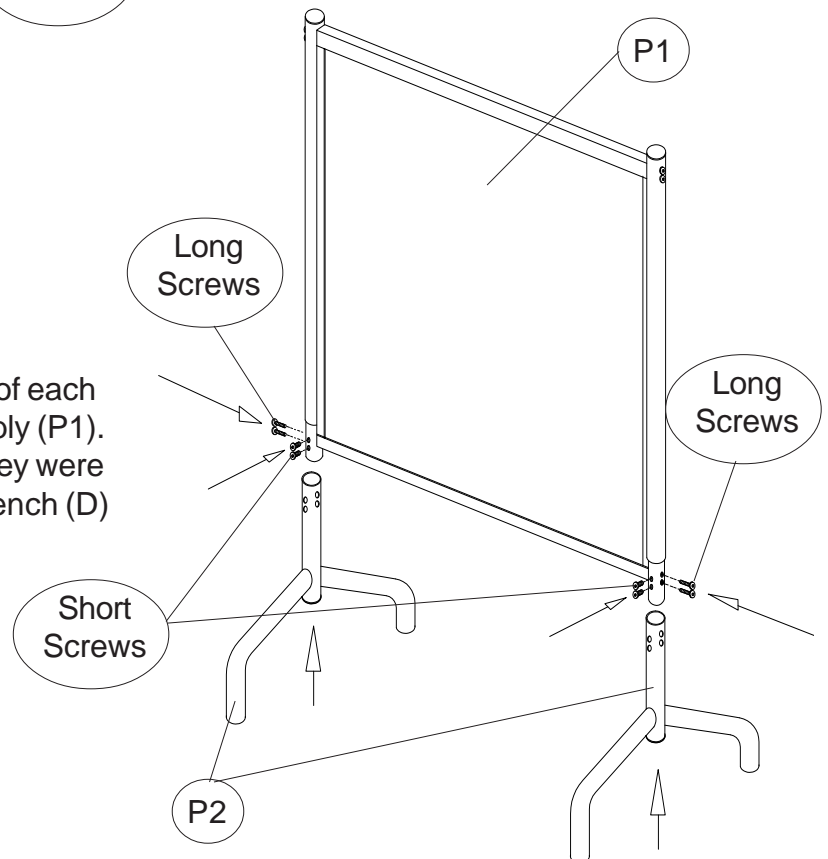
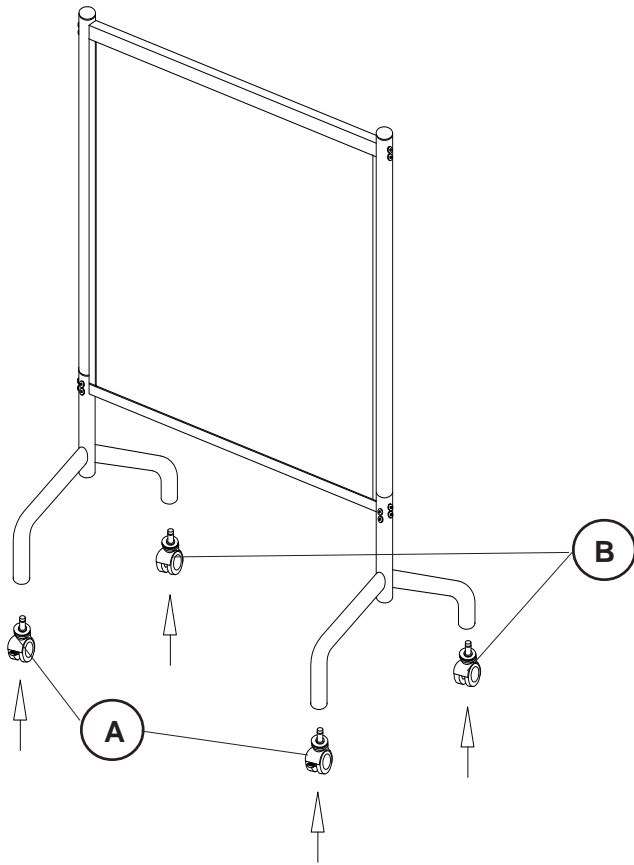

Illustration # 2

- 4.) Push two Locking Casters (A) into the bottom of the front legs as shown in illustration #3. Push in two Casters (B) into the rear legs.

Illustration # 3



- 5.) Attach the two Chart Hooks (C) over the top extrusion of the Panel Assembly (P1). Attach your magnetic Tray (E) to the front of the Panel Assembly (on Magnetic Boards only).

Illustration # 4

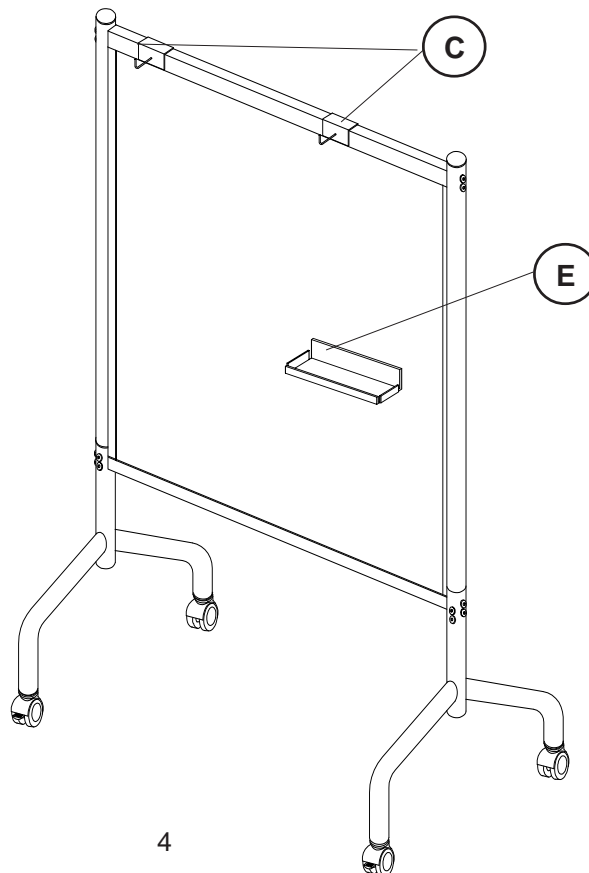

Essential Mobile Whiteboard

