

# 27735 Power Tower

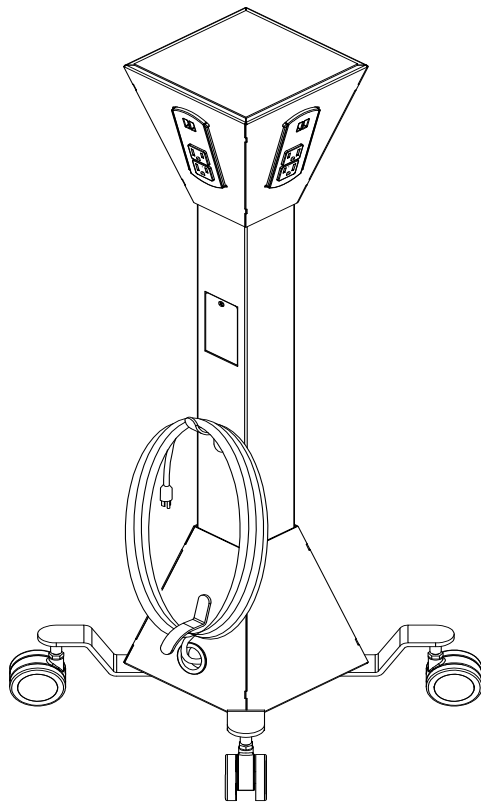

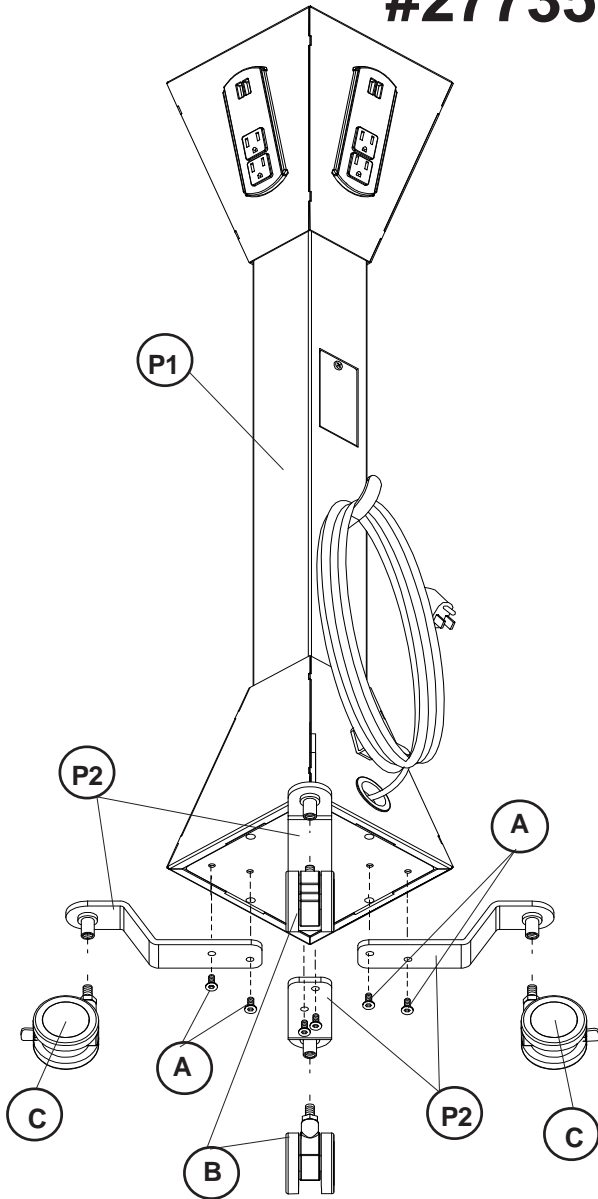



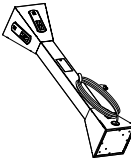
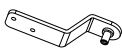

## Assembly Instructions

# #27735 Power Tower



## Part List

Part	Drawing	Description	Qty
P1		Power Tower	1 EA
P2		Foot	4 EA
Hardware List			
Part	Drawing	Description	Qty
A		Screw	8 EA
B		Caster	2 EA
C		Locking Caster	2 EA
D		Allen Wrench	1 EA
E		Caster Wrench	1 EA

## Assembly Instructions

1. Separate and Identify all parts.
2. Attach the Foot (P2) to the bottom of the Power Tower (P1) using two Screws (A) as shown in the illustration above. Tighten the Screws using Allen Wrench (D).
3. Repeat Step 2 to install the other three Feet.
4. Screw in two Casters (B) into the bottom of two Feet (P2) as shown. Tighten Caster using Caster Wrench (E).
5. Repeat Step 4 to install the two Locking Casters (C) as shown.

**CAUTION: TO REDUCE THE RISK OF ELECTRIC SHOCK-  
USE ONLY INDOORS.**