









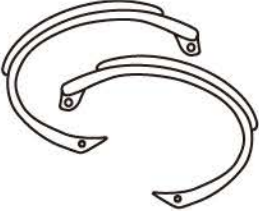
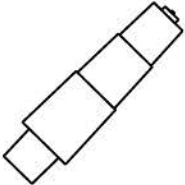

**Please unscrew mechanism and L-bar hardware from cushion before assembly.**

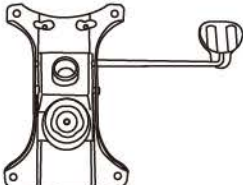
**Por favor de destornillar todos los tornillos del cojín antes de ensambla la silla.**

**MODEL : B726**

(1)x1  Back Cushion	(2)x1  Seat Cushion	(3)x1 (L)x1 (R)  Left-Arm-L Right-Arm-R
(4)x1  Gas Lift W/ Cover	(5)x1  Base	(6)x1  Mechanism
(7)x5  Caster		
(A)x4  M8 X 22 MECHANISM SCREW		
(B)x4  M8 X 30 L-bar SCREW		
(C)x4  M8 X 45 ARM SCREW		
(D)x4  ARM CAPS		

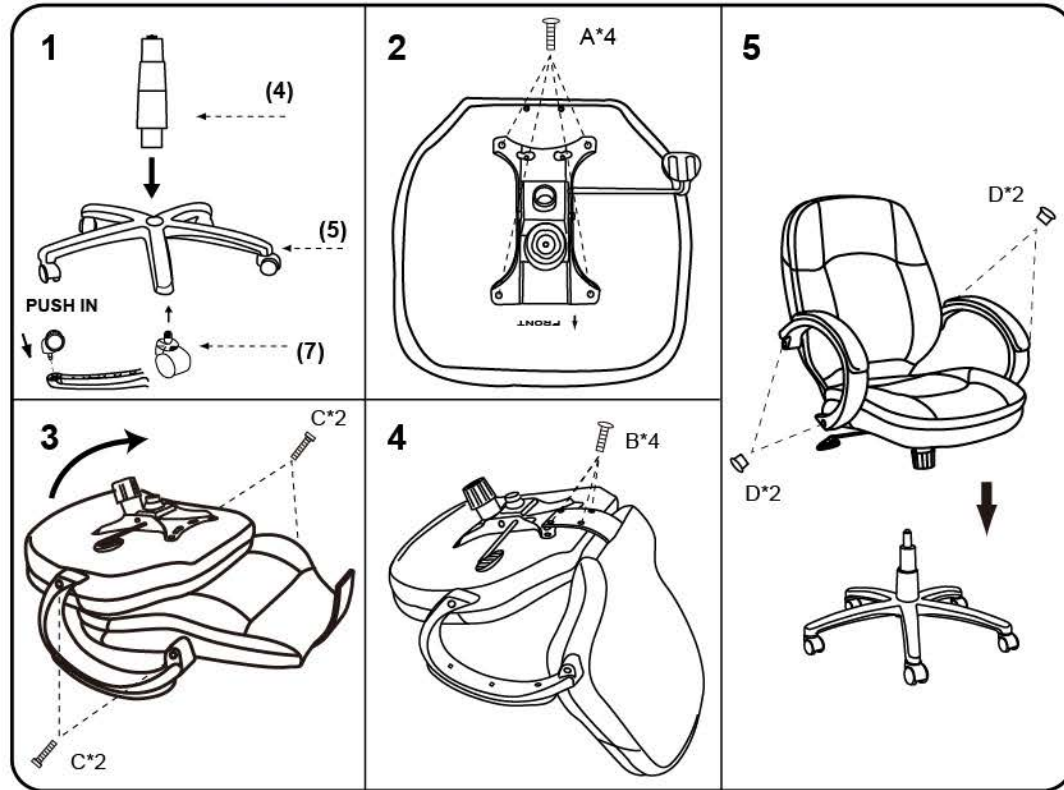

**Note: Please tighten all arm screws using allen key before step 5**

Insert and loosely tighten all screws. When assembly is completed, fully tighten all screws before using. This chair is only intended for sitting. Any other use will void the warranty.



**If the chair is not working properly, is missing a part, is damaged, or if you have any questions, please call customer service hotline before returning.**

**Customer Service Hotline: 1-800-593-1888 For further assembly instructions, please visit our website at [www.bosschair.com](http://www.bosschair.com)**