



-- Gym Glide™ --
(Recreational Game Standard)
Installation Instructions







Call Jaypro Sports Equipment at 1-800-243-0533
during regular business hours for technical support.

www.jaypro.com

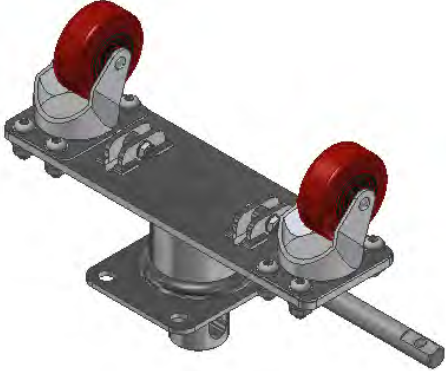
JAYPRO SPORTS
Gym Glide™ Recreational Game Standard

ITEM	IMAGE	DESCRIPTION
1		QTY: 1 EACH GAME BASE (COLOR MAY VARY)
2		QTY: 1 EACH BOTTOM UPRIGHT TUBE DO NOT REMOVE OUTER PLASTIC SLEEVE!!!!
3		QTY: 1 EACH TOP UPRIGHT TUBE (66 3/4" LONG)
4		QTY: 1 EACH 2" ROUND CAP
5		QTY: 1 EACH COLLAR FOR TOP UPRIGHT TUBING
6		QTY: 2 EACH COLLAR FOR BOTTOM UPRIGHT TUBING
7		QTY: 1 EACH 3/8" DIA x 2-1/2" QUICK-RELEASE PIN BALL HANDLE, ZP
ITEM	IMAGE	DESCRIPTION

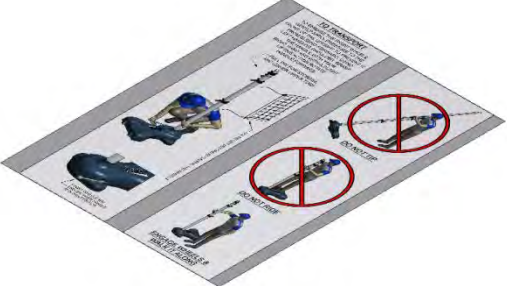
ITEM	IMAGE	DESCRIPTION
8		<p>QTY: 1 EACH 3/8"-16 x 6" LONG BALL HANDLE</p>
9		<p>QTY: 1 EACH FRONT WHEEL ASSEMBLY</p>
10		<p>QTY: 1 EACH 1/2" I.D. x 3/4" O.D. x 1" L. (FLANGE 1" O.D. x 1/8" L.) SAE 841</p>
11		<p>QTY: 1 EACH GAME BASE HUB HANDLE WITH CONE POINT SELF LOCKING SET SCREW (PRE-ASSEMBLE)</p>
12		<p>QTY: 1 EACH (4 IN A SET) 5/16"-18 x 1" LONG BUTTON HEAD SCREW WITH LOCK WASHER AND WASHER</p>
13		<p>QTY: 1 EACH WARNING LABELS</p>
ITEM	IMAGE	DESCRIPTION

IMPORTANT NOTICE:

- 1) BEFORE EACH USE CHECK EQUIPMENT FOR PROPER CONNECTING HARDWARE AND STRUCTURAL INTEGRITY. REPLACE DAMAGED OR MISSING HARDWARE IMMEDIATELY.
- 2) USE OF THIS EQUIPMENT OTHER THAN INTENDED, MAY BE HAZARDOUS.
- 3) ALTERATION OR MODIFICATION OF THIS EQUIPMENT MAY BE HAZARDOUS AND RESULT IN INJURY. FOR REPAIR OR REPLACEMENT, CONTACT YOUR DEALER OR JAYPRO SPORTS.

ASSEMBLY INSTRUCTIONS

TOOLS REQUIRED:

- 1/4" T-Handle Allen Wrench (included)
- 1/8" Allen Wrench (included)
- Loctite Blue Thread-Lock (included)
- Rubber Mallet
- White Lithium Grease Spray

IMPORTANT: Assembling the uprights and front wheel assembly is a two person job. The base needs to be stood up on the rear wheels, while the upright pole is inserted through the base hub. One person will steady the base while the other inserts the upright pole. Extreme care should be taken to avoid dropping the base on fingers and toes.

Assembly Steps:

1. With the base still on the pallet, cut away and remove the protective wrap from the base. Leaving the wood blocking behind the rear wheels.
2. Carefully lift the front of the base and remove the package containing the front wheel assembly.
3. Unpack all parts and check against the parts list. Inspect all parts for damage.
4. Unpack the uprights but do not remove the outer plastic sleeve from the bottom upright, as it will be needed to protect the finish on the upright as it is inserted. Remove the top upright and set it aside.
5. Prepare a stand, 24" high that will be used to rest the upright on after it has been installed. Place the stand 4 to 5 ft behind the rear wheels of the base.
6. Carefully lift the front of the base standing it upright. **Ensure that the rear wheels are against the wooden block to prevent the base from rolling back off the pallet.** With the base standing up, now place a foot in front of one of the rear wheels to prevent it from rolling forward.
7. Securely hold the base vertically upward. With one person holding the base have the other person carefully slide the bottom upright through the hub. The plastic sleeve will protect the outer surface from being scratch while being inserted. As the upright in being inserted have it eventually rest on top of the 24" tall stand.
8. Once the upright tube is fully inserted line up the mounting holes in the base plate. The base will now support itself.
9. Remove the black hub and bronzed bushing from the front wheel assembly.
10. Separately operate the wheel assembly, extending and retracting the linkage and wheel plate. Make sure the main shaft slides in and out easily. If there is any hint of binding spray the shaft with lithium spray grease, and work the assembly back and forth.

11. With the wheel assembly in the fully extended position, slide the actuating shaft through the opening in the side of the base.
12. Line up the holes and install the four 5/16"-18 x 1" long button head screws with lock washer and washer. Partially install one at a time, but do not tighten down.
13. Slide the bronzed bushing onto the actuating shaft and insert it into the base.
14. After all screws are inserted, progressively tighten them in a random sequence. Do not tighten in one shot, and do not over tighten!
15. Install the black hub onto the actuating shaft as shown, paying particular attention to its orientation. *You may need to back the set screw out to allow it to slide onto the shaft.*
16. Apply Loctite to the threads on the end of the handle and then thread the handle into the hub. Securely tighten the handle onto the hub.
17. Securely tighten the set screw in the hub. Operate the wheel assembly using the handle, making sure it operates freely.
18. Carefully lift the upright and set the assembled base down into its normal position. Carefully maneuver the base off the pallet, without letting it drop hard on the rear wheels.
19. Insert the top upright tube into the bottom upright tube. Note that the top end has a thru-hole closest to the end of the tube.
20. Slide the collars onto the uprights, clamping them into position. Insert the cap into the top of the upright tubing.
21. Raise the top upright tubing until the holes in both the uprights are aligned and insert the 3/8" quick-release pin ball handle to lock them in place.
22. Apply warning labels to bottom upright as shown.

Continue to next page for assembly illustration.

Stand 4 or 5 Feet Back.

Bottom Upright Tube
With Outer Plastic .Sleeve.

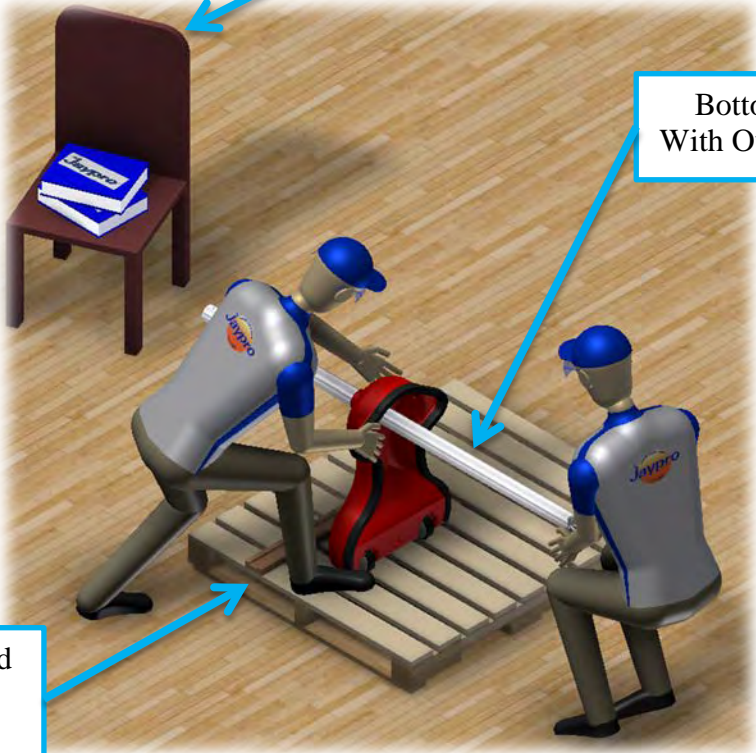

Wood Block Behind
The Rear Wheels
Do Not Remove.

Bottom Upright
To Rest On Stand.

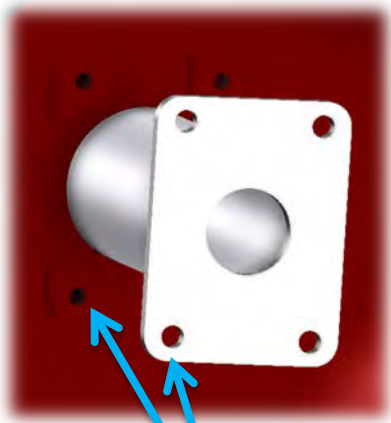
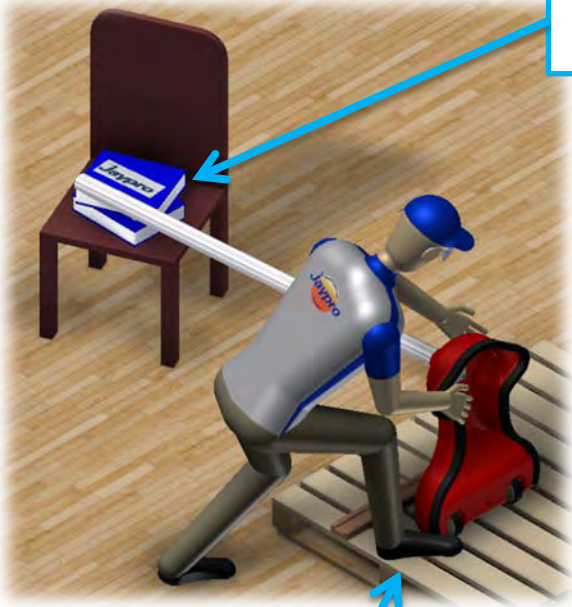

Foot In Front
Prevent From Moving.

Line Up The
Mounting Holes

Remove Black Hub & Bronzed Bushing.

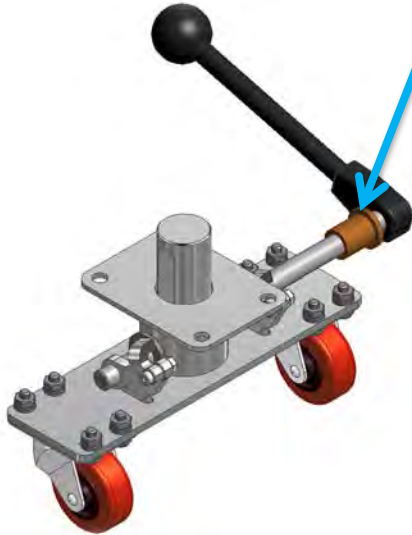

Actuating Shaft.

Once Fully Extended
Slide Into Base.

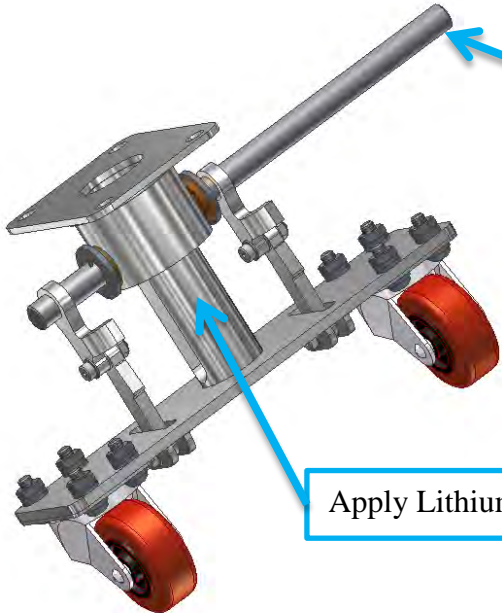

Apply Lithium Spray Grease If Binding Occurs.

Once Fully Extended Slide Into Base.

Slide Actuating Shaft Through Opening.

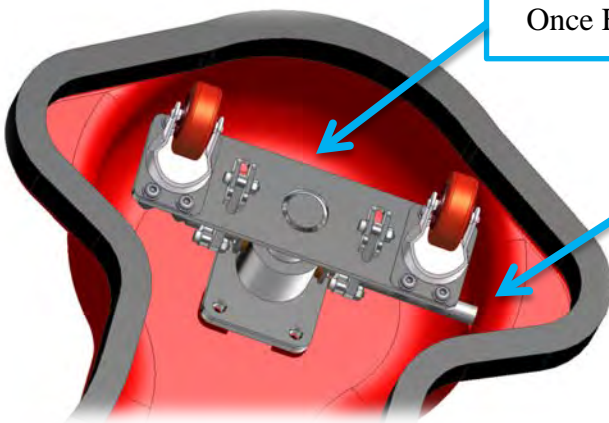

Tools Required:
1/4" T-Handle Allen Wrench (included)

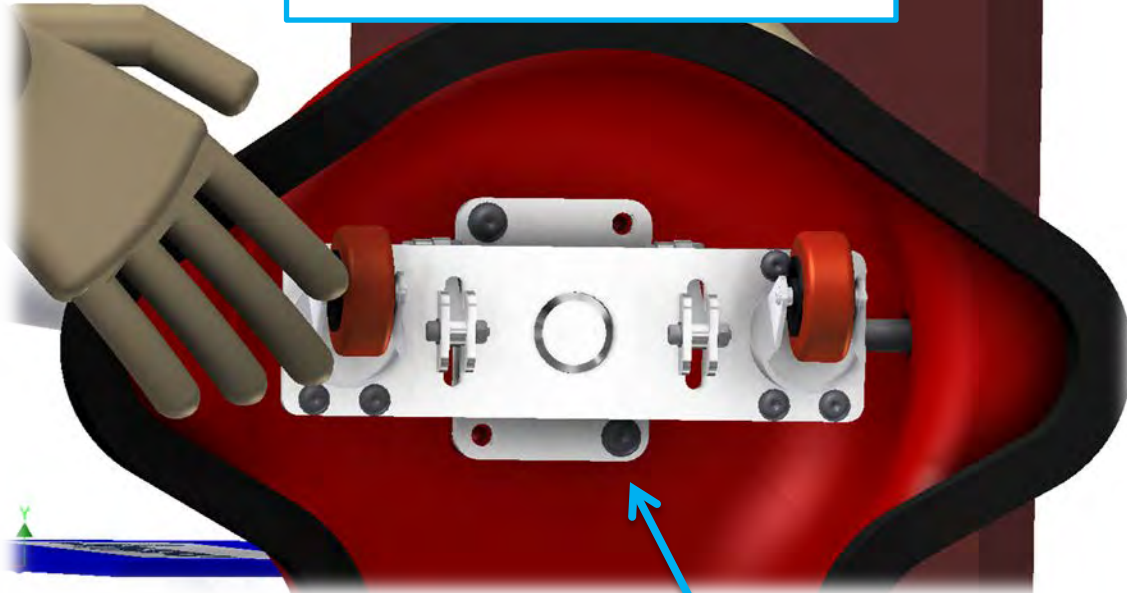

Partially Install One At A Time
Do Not Tighten Down.



QTY: 1 EACH (4 IN A SET)
5/16"-18 x 1" LONG BUTTON HEAD SCREW
WITH LOCK WASHER AND WASHER

After all screws are inserted, progressively
tighten them in a random sequence. Do not
tighten in one shot, and do not over tighten!

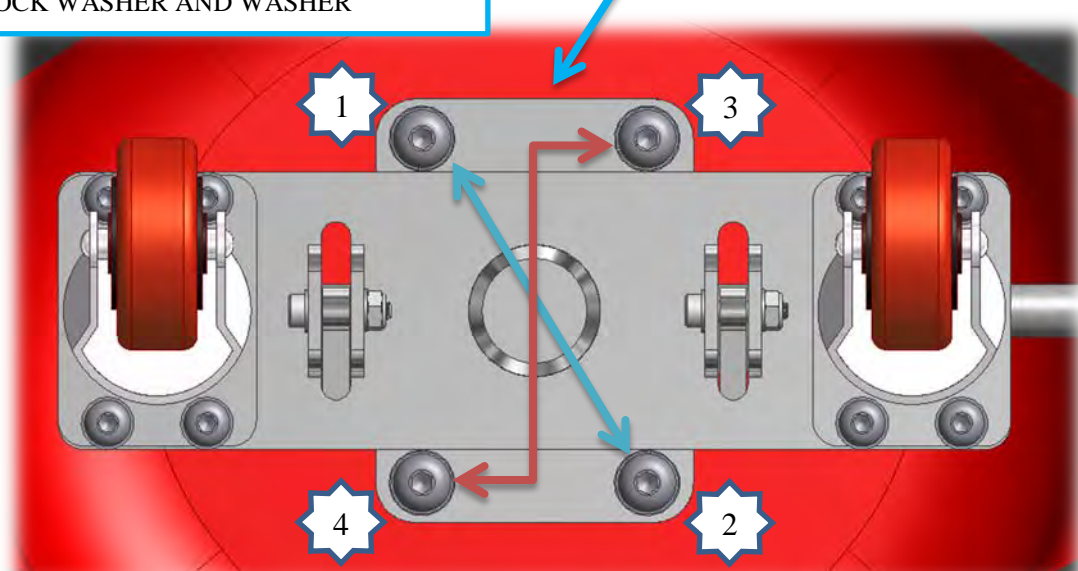

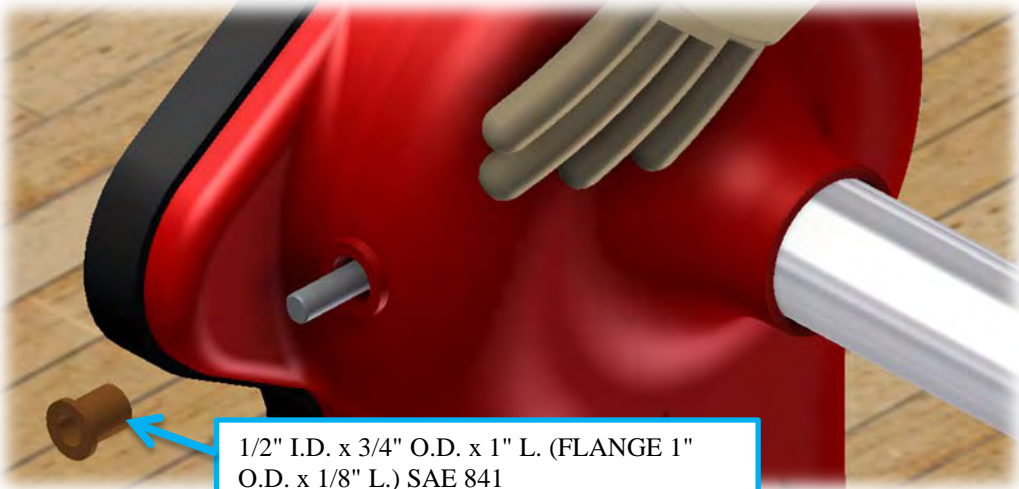

1/2" I.D. x 3/4" O.D. x 1" L. (FLANGE 1" O.D. x 1/8" L.) SAE 841

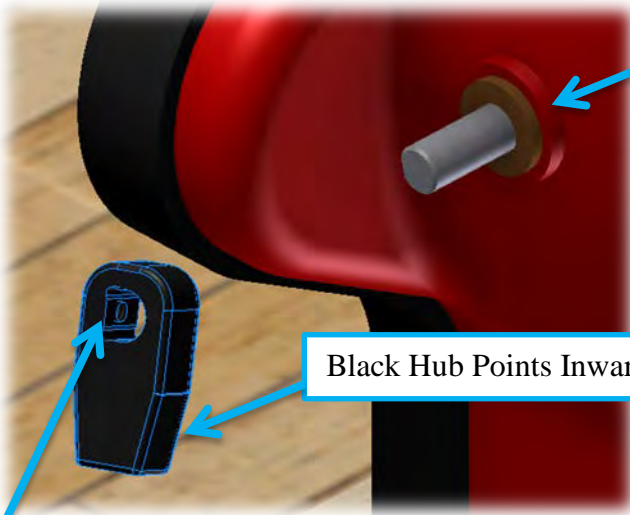

If unable to slide bushing on to shaft loosen the hardware that holds the upright.

Black Hub Points Inward Base.



Back Set Screw Out Before Sliding.

3/8"-16 x 6" LONG BALL HANDLE



Apply Loctite To Thread Then Screw Handle On.

Use 1/8" Allen Wrench To Securely Tighten The Set Screw In The Hub.

Operate The Wheel Assembly Using The Handle, Making Sure It Operates Freely.

Carefully Lift The Upright And Set The Assembled Base Down Into Its Normal Position.

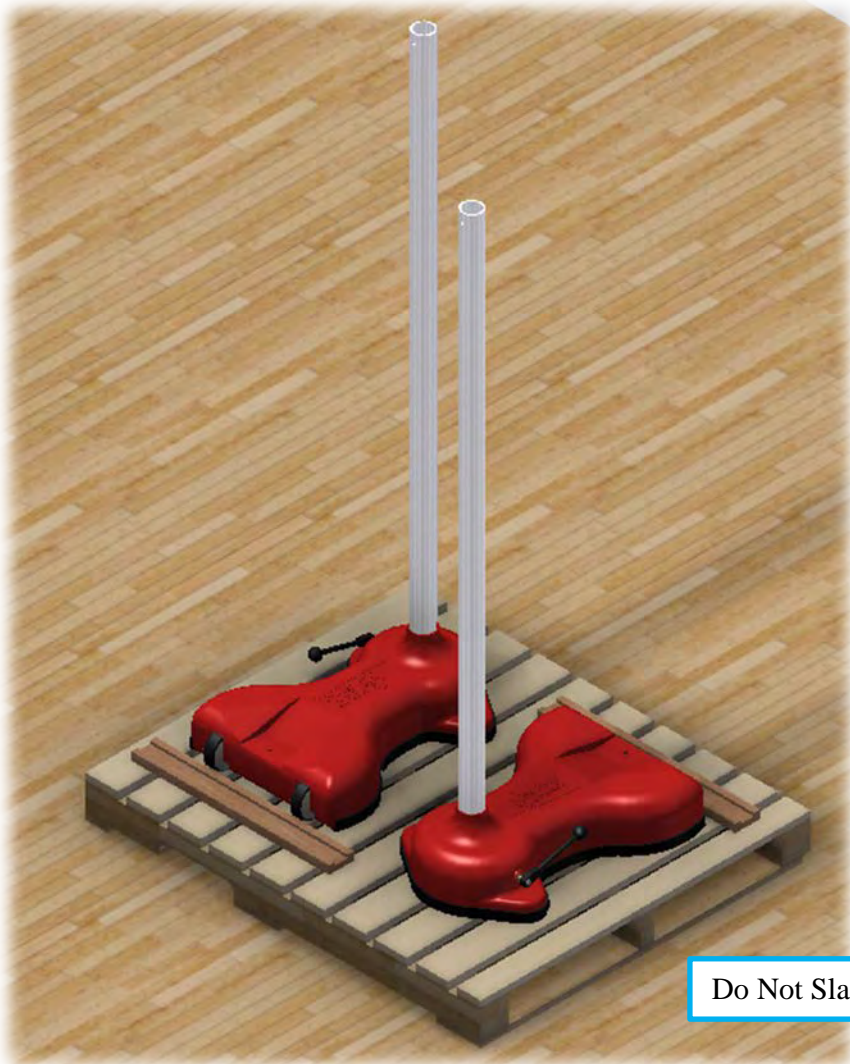

Do Not Slam Rear Wheels On Floor.



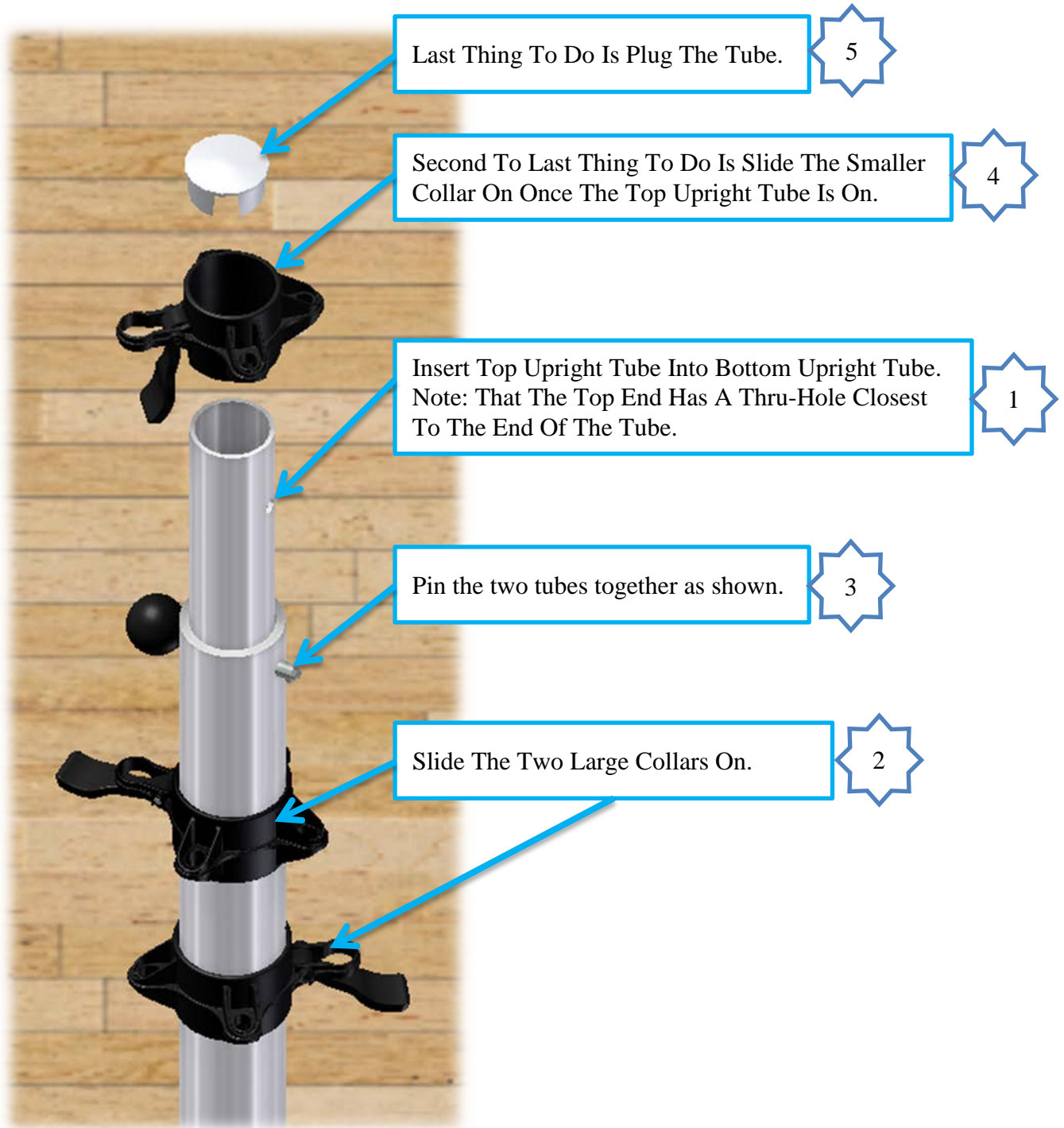

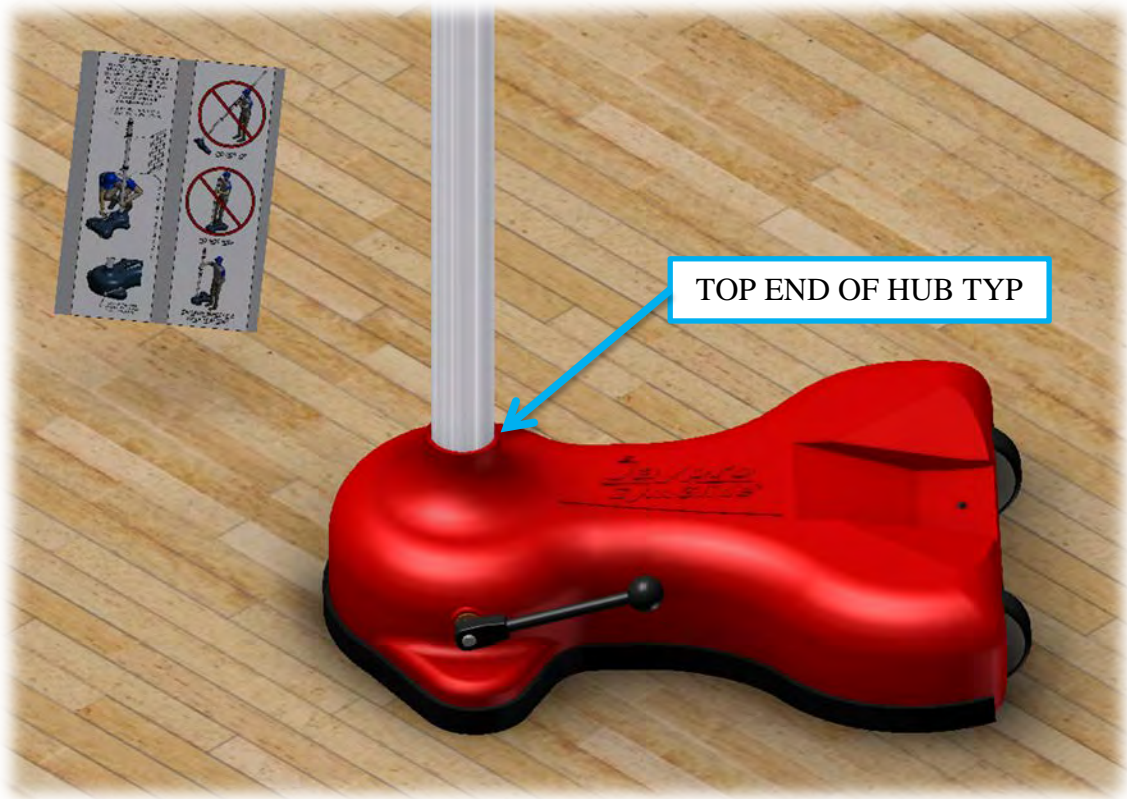

TOP END OF HUB TYP

