

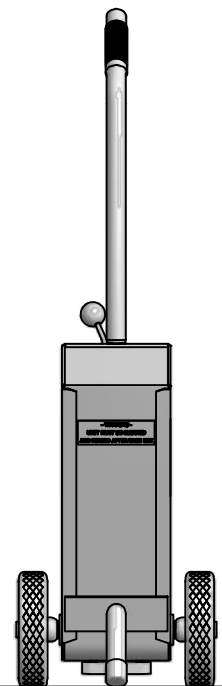

TOOLS REQUIRED:
1) PHILIP HEAD SCREW DRIVER

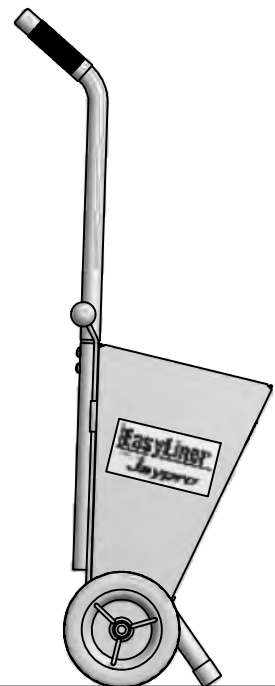
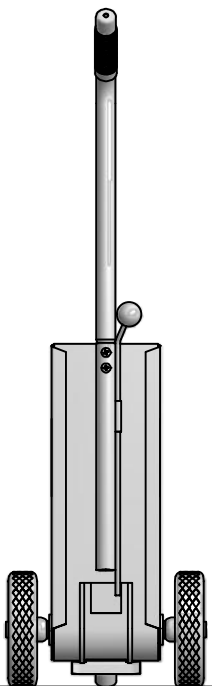
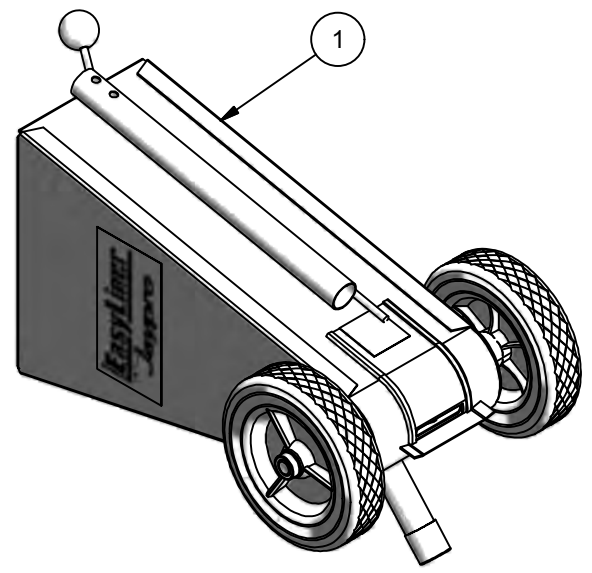
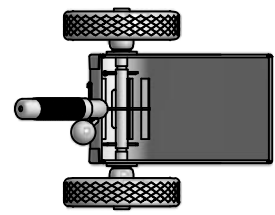
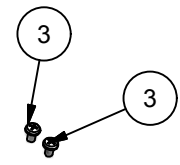

ITEM	QTY	PART #	REV	DESCRIPTION
1	1	FM-10R-FA	-	10 LBS HOPPER ASSEMBLY
2	1	FM10R-D	-	10 LBS SWAGE HANDLE
3	2	FM-0BD	-	M6 x 10mm ROUND PAN HD, SS

 976 Hartford Turnpike Waterford, CT 06385 USA (800)243-0533 Fax: (800)988-3363 www.jaypro.com	MODEL NUMBER: FLMR-10		CHECKED BY: WVB	
	PRODUCT NAME: 10 LBS LINE DRY MARKER			
	DATE: 5/7/2012	REV: A	DRAWN BY: Moune T.	SHEET: 1 OF 1