



JAYPRO PVB SERIES CLASSIC STEEL COLLEGIATE NET SYSTEM

Installation and Operating Instructions

Applicable Part Numbers/Models:

PVB-3000: Classic Steel Collegiate Net system

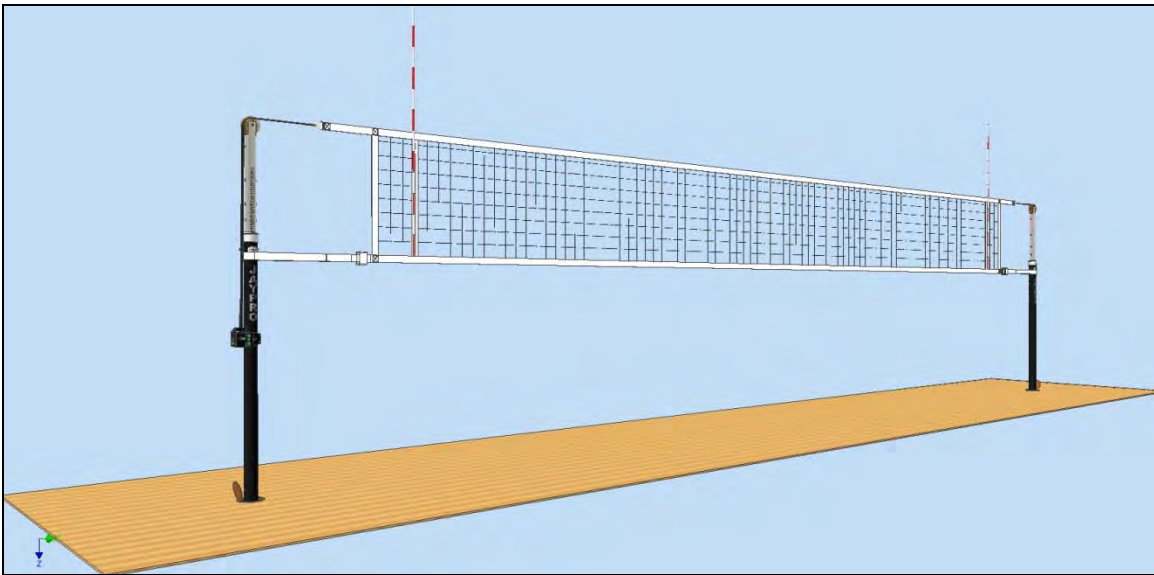

Table of Contents

1	Safety.....	2
2	Specifications.....	2
3	Introduction.....	2
4	Required Tools.....	3
5	Included Hardware & Components.....	4
	5.1 System Components.....	4
	5.2 Hardware.....	5
6	Assembly.....	6
7	Maintenance.....	9

1 Safety

- **WARNING: Do not attempt to remove the height adjuster pin if the net is under tension.**
- **WARNING: Always use protective padding around each upright during use.**
- **WARNING: Uprights are heavy. Do not attempt to lift or install without assistance.**
- **IMPORTANT: Follow all warning labels on equipment.**
- **IMPORTANT: Inspect for damage before and after each use.**

2 Specifications

	UPRIGHT OUTER DIAMETER	HEIGHT RANGE	# OF POSITIONS	WEIGHT	UPPER UPRIGHT MATERIAL	LOWER UPRIGHT MATERIAL
PVB-3000	3" (76mm)	6'6" to 8'2" (2.0m to 2.5m)	16 Pin Stops	157 lbs (71kg)	Aluminum 6063	Steel

3 Introduction

Note: The Flex Net supplied with this system will stretch slightly during the first few uses. This is a natural consequence of the headband fibers being stretched under tension. During this break-in period, the headband and net body may sag during use. Simply increase tension (center if necessary) to remove the sag.

These instructions assume that the appropriate ground sleeves have been correctly installed:

- The inside bottom surface of the ground sleeves must be 10" below ground level (Figure 3-1).
- The standards will fit most 3" inner diameter ground sleeves (or 4" ID sleeves with adapter).
- The Flex-Net will work with ground sleeves spaced 35' to 37' apart on center¹.

Please consult the instructions and specifications supplied with your ground sleeves for more information.

If you require additional information or support to install or operate your volleyball system, please contact the Jaypro Sports customer support team, Monday through Friday, 8:30AM to 5:00 PM (EST), at 1-800-243-0533.

¹ NCAA and NFHS rules require that the upright standards must be installed at least 3'3" (1m) outside the court boundaries. Jaypro recommends 36' spacing on center to satisfy both regulations.

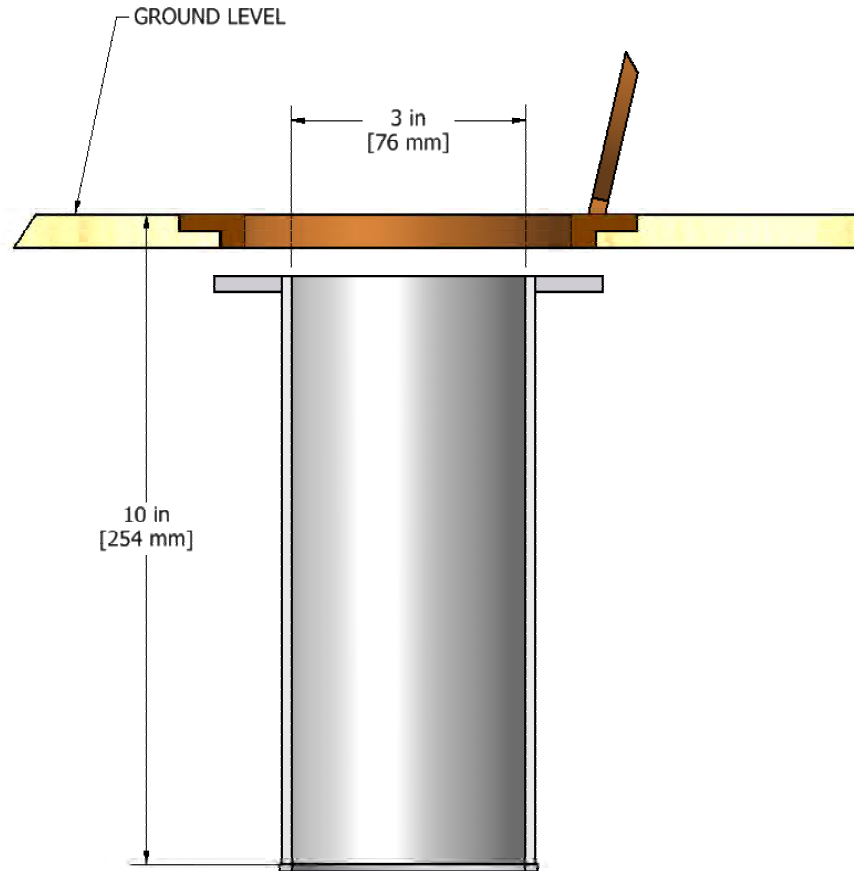

Figure 3-1: Correct Ground Sleeve Dimensions

4 Required Tools

Before continuing, please verify that you have the following tools required to complete the installation and setup of your PVB Series Collegiate Net System.

- Adjustable wrench
- Hex keys – 3/16", 5/16"

5 Included Hardware & Components

Before continuing, please open all packages to verify that you have all the required hardware for installation and setup. If any of the following items are missing, contact the Jaypro Sports customer support team, Monday through Friday, 8:30AM to 5:00 PM (EST), at 1-800-243-0533.

5.1 System Components



Figure 5-1: PVB-3000 Standard Upright (PVB300B, 2X).



Figure 5-2: Winch with strap (PVBWINCH, 1X).

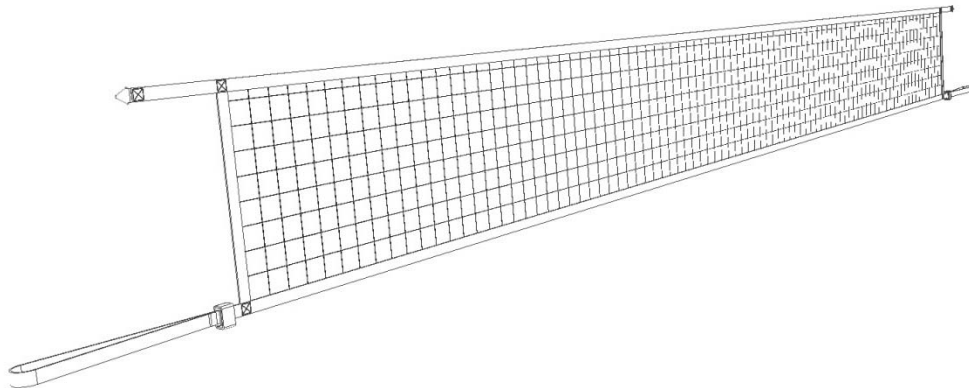

Figure 5-3: Flex-Net (PVBN-6, 1X)

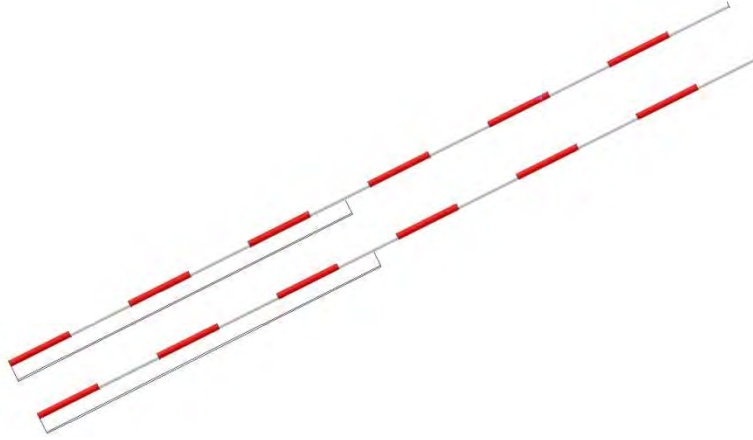

Figure 5-4: Antennae and Net Tapes (VBA-4, 1 pair)

5.2 Hardware



Figure 5-5: Net extension cord 31 inches (PVBN6R2, 2X)



Figure 5-6: Socket Cap Screw (HS5082, 1X)



Figure 5-8: Centering Strap (PVB604, 1X)



Figure 5-9: Acorn Nut (HN6112, 2X)



Figure 5-10 Spacer (HM6347, 1X)



Figure 5-11: Button Head Screw (HS5240, 1X)



Figure 5-12: Carabiner (HM5054, 2X)

6 Assembly

WARNING: Uprights are heavy. Do not attempt to lift or install without assistance.

1. Install each upright into the ground sleeves.
2. Follow instructions included with winch to set the winch clamp to the correct upright diameter (3").
3. Install winch to one upright using the socket cap screw and acorn nut (Figure 6-1, items 1 & 2).
4. Fasten the clamp together using the cap screws supplied with the winch (Figure 6-1, item 4-1).

ITEM	QTY	PART NUMBER	DESCRIPTION
1	1	HN6112	Acorn Nut
2	1	HS5082	Socket Head Cap Screw
3	2	PVB300B	PVB-3000 Standard Upright
4	1	PVBWINCH	Volleyball Winch
4-1	2	N/A	Clamp Bolt - Included with PVBWINCH



Figure 6-1: Winch installation.

5. Install 31 inch net extension cord and the centering strap assembly to the upright without the winch. (Figure 6-2).

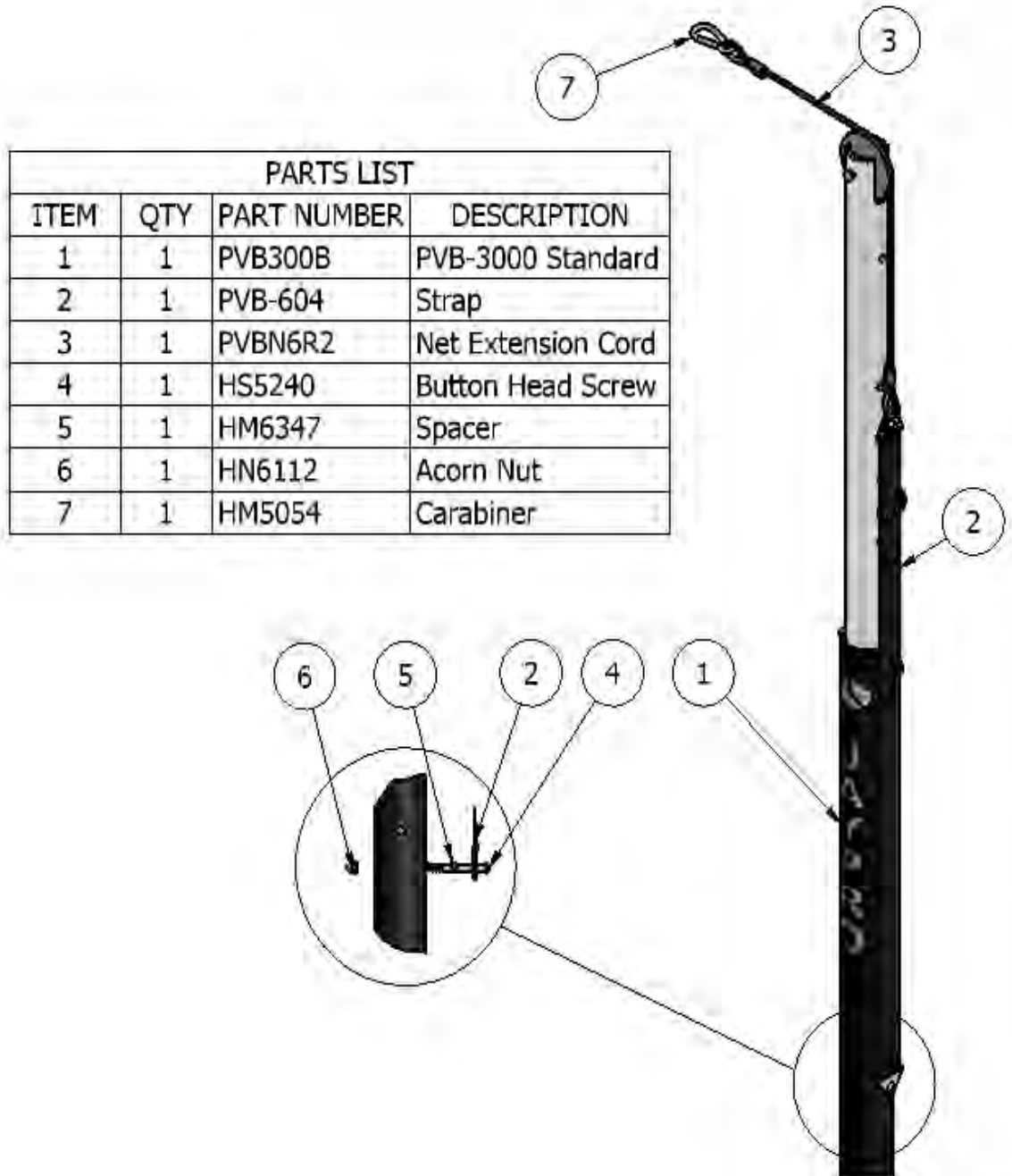

Figure 6-2: Install net extension cord to anchor side.

- Attach one end of net to 31 inch Extension Cord with the Carabiner provided, then attach other end of the extension cord to the winch strap (Figure 6-3).

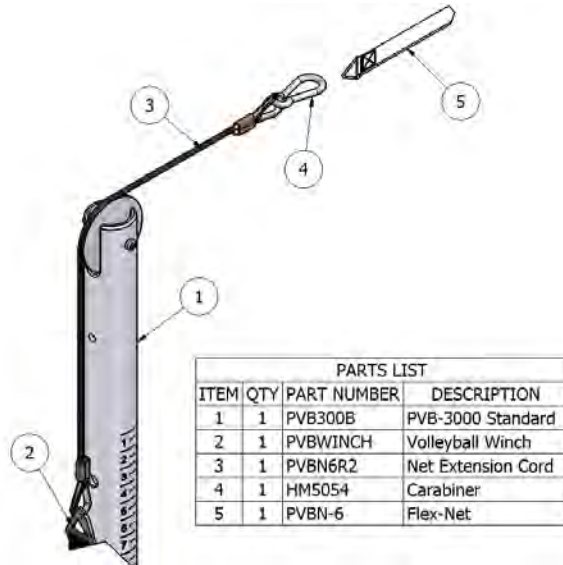

Figure 6-3

: Attach net to straps.

- Set the height of the uprights using the installed height adjust pin (Figure 6-4).
*****WARNING: Do not attempt to remove the height adjuster pin if the net is under tension.**



Figure 6-4: Set upright height.

*****The net will stretch ~6 – 8 inches when tension is applied so you must factor this in before applying tension when centering the net.**

8. Tension the net by turning the winch handle clockwise². Adjust anchor strap as necessary to keep net centered.
9. Verify net heights and net centering. The uprights will deflect inward and downward due to net tension; you may need to adjust their heights and/or re-center the net. **WARNING: Release tension from the net before removing height adjust pin.**
10. Attach the bottom net straps to each upright as shown in Figure 6-5. Wrap Velcro straps around buckles for additional player safety.

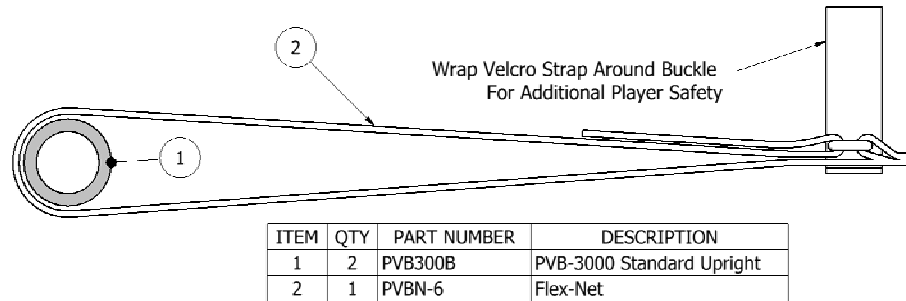

Figure 6-5 : Secure bottom net straps to uprights.

11. Attach net antennae and tapes according to instructions included with antennae set.
12. Install pads around each upright.

7 Maintenance

Your PVB Series Classic Steel Collegiate Net System is designed to provide years of play; however, it is recommended that the components be inspected at least once every season, for signs of excessive wear. Key areas to inspect include (but are not limited to):

- Strap webbing
- Net
- Spring clips and D-rings
- Winch mechanism
- Screws and nuts

If you require additional information or support maintaining your volleyball system, please contact the Jaypro Sports customer support team, Monday through Friday, 8:30AM to 5:00 PM (EST), at 1-800-243-0533.

² NCAA and NFHS rules stipulate that there be no more than 3/4" of sag in the net headband when fully tensioned.