

No. 5589

SHERPA[®] infobase telescope

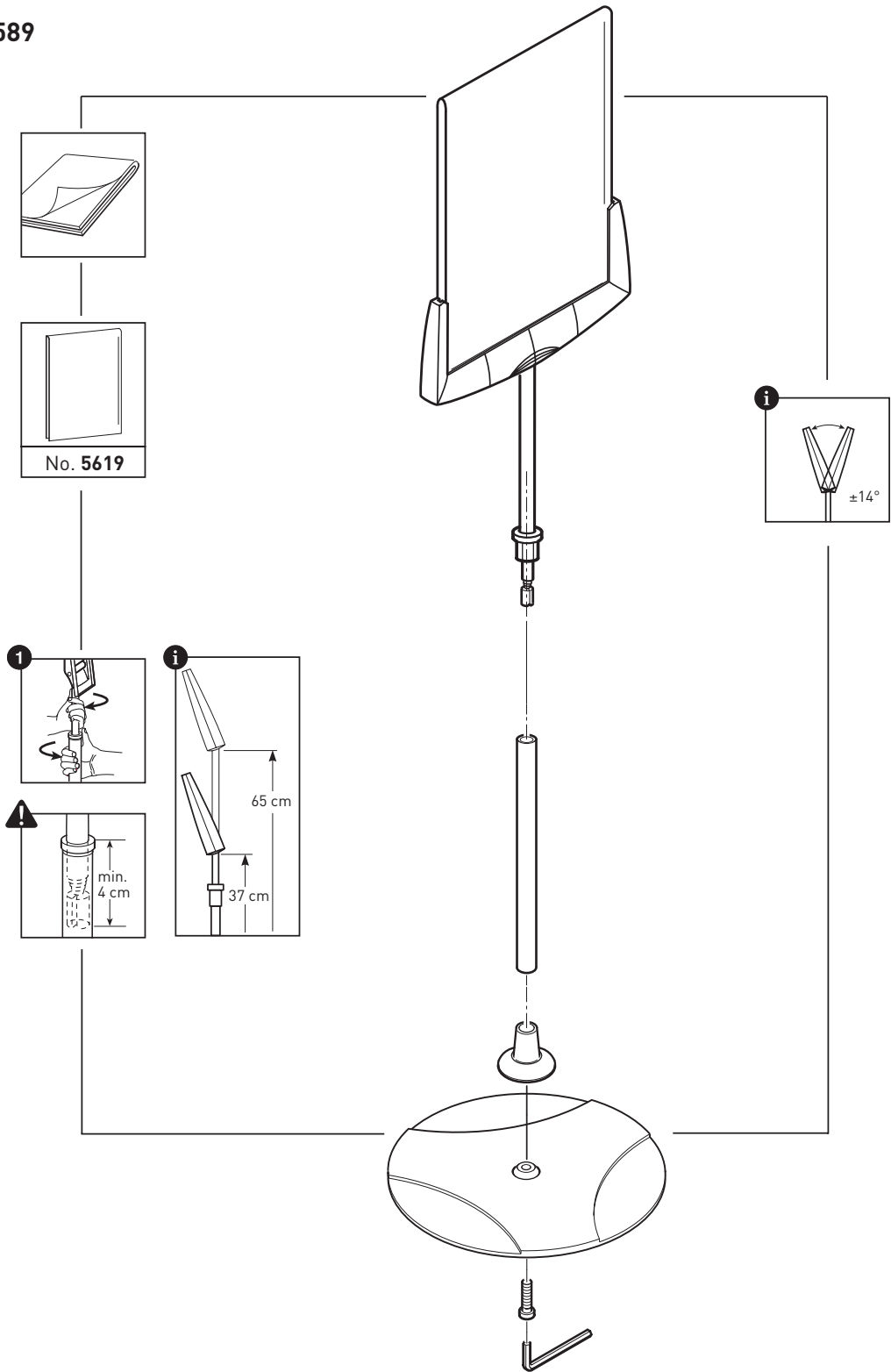

SHERPA®

Sichttafel-System · Sortimentsauszug
Display Panel System · Extract of the range
Système de plaques à pochettes · Extrait de la gamme
Sistema de fundas transparentes · Extractp de la gama

No. 5606

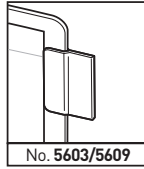

No. 5607

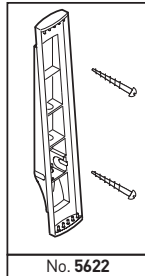
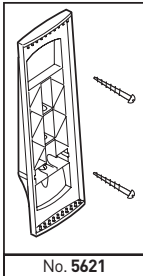
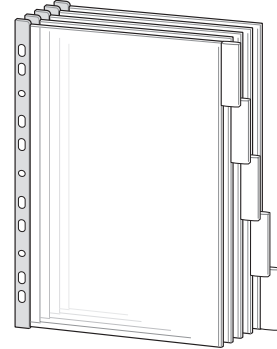

No. 5621

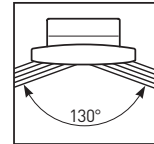
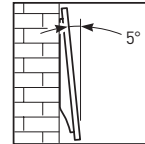
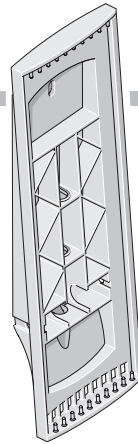

No. 5626

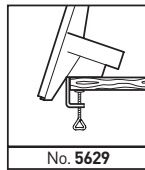
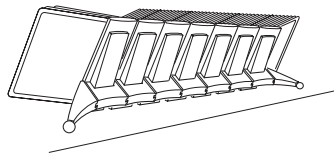

No. 5629

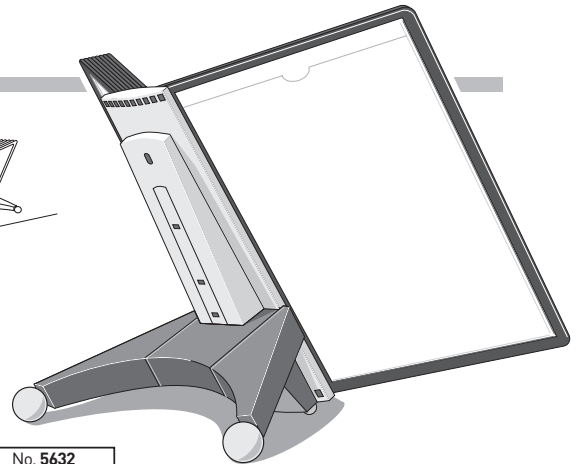

No. 5632

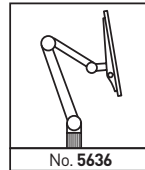
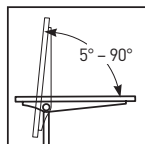

No. 5636

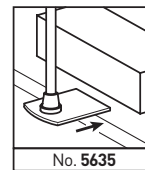

No. 5635

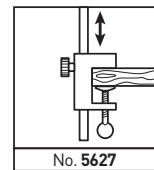

No. 5627



DURABLE

DURABLE · 58634 Iserlohn · Germany
www.durable.de