

WARNING

- 1 Use this product only one person at a time.
- 2 Use this product for its intended purpose.
- 3 Do not stand on product.
- 4 Do not use this product as a step stool or ladder.
- 5 Do not use product unless all metal fasteners are tight. At least every six months, check all fasteners and joints to ensure they are tight.
- 6 Open only one drawer at a time on any unit with drawers.
- 7 Do not modify product in any way.
- 8 If any parts are missing, broken, damaged or worn, stop use of the product until repairs are made using factory authorized parts.
- 9 Dispose of packing material properly. Do not use any packing materials as head covering. It may cause suffocation
- 10 Failure to follow these warnings could result in serious injury.

LIMITED WARRANTY

ProLine II Casegoods are warranted against failure due to materials and workmanship as follows:

- Prado Collection = 5 years

All warranties are limited to the original purchaser for normal commercial usage

Exclusions

This warranty will not cover labor, freight or damage from misuse, abuse, negligence, alteration, assembly, installation, attachments, accident, vandalism, acts of nature or any other event beyond the control of Office Star Products. The warranty does not cover cosmetic damage that may result from normal use. Liability for incidental or consequential damage is excluded. The user assumes all risk of injury resulting from use of this product.

This warranty applies only to products purchased through authorized Office Star dealers and products sold within the United States of America and the Commonwealth of Canada. This warranty does not apply to products used for rental purposes. This warranty gives you specific legal rights, and you may also have other rights which vary from state to state.

Claims

To make a warranty claim, contact parts@officestar.net with the following:







- Model number
- Description of problem
- Digital images
- Original OSP invoice number or customer purchase order number

At its option, Office Star Products will:

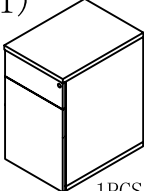
- a) Supply compatible components of current manufacture
- b) Repair the customer's component. The customer must prepay freight on any components returned to the factory. Return freight on components still in warranty will be paid by Office Star Products.

Contacts

Our quality standards are among the highest in the industry. Sometimes, no matter how hard we try, there are times when parts are damaged or missing. Our Parts Department will do everything possible to promptly remedy the problem. Contact us via e-mail parts@officestar.net, by Fax 1-909-930-5629, or toll free parts number 1-800-950-7262, Monday through Friday 8:00 a.m. - 5:00 p.m. Pacific Time.

<p>(1)</p>  <p>1PCS</p>	<p>(A) Bolt</p>  <p>4PCS</p>	<p>(B) Wood Screw</p>  <p>20PCS+2</p>	<p>(C) Drawer Pull</p>  <p>2PCS</p>	<p>(D) Caster H=63</p>  <p>3PCS</p>	<p>(E) Brake Caster H=63</p>  <p>2PCS</p>
---	---	--	--	--	--

STEP 1

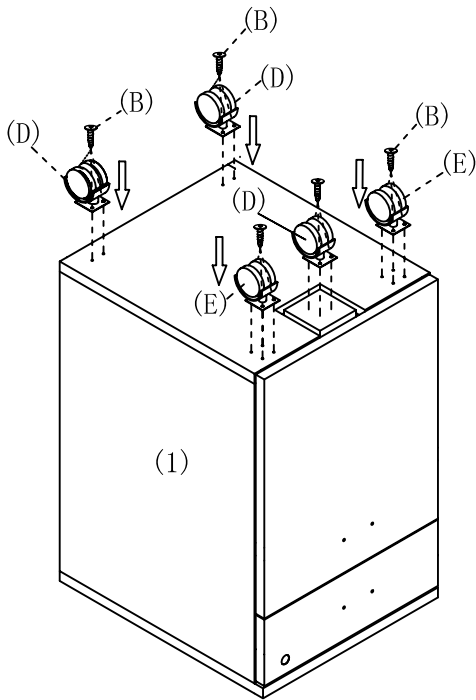

STEP 2

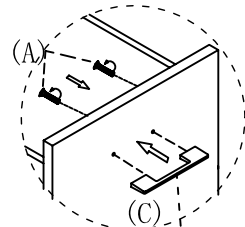
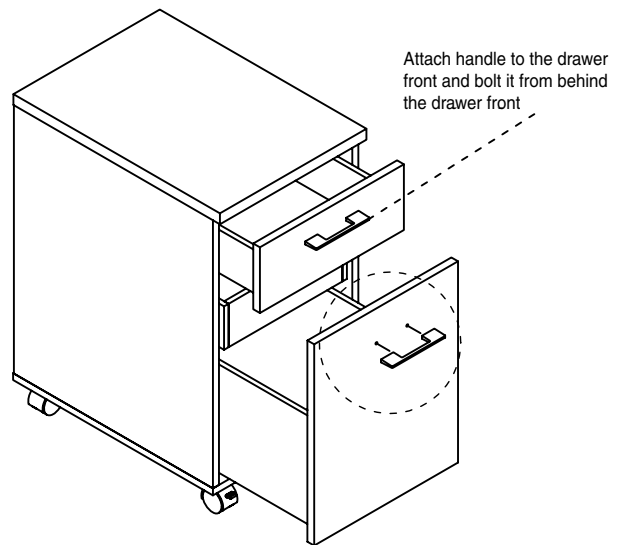

Attach handle to the drawer front and bolt it from behind the drawer front