

**BEST-RITE®**

*"It's A Better Board"*

**749 MFE**

**Magnetic Flannel Easel**

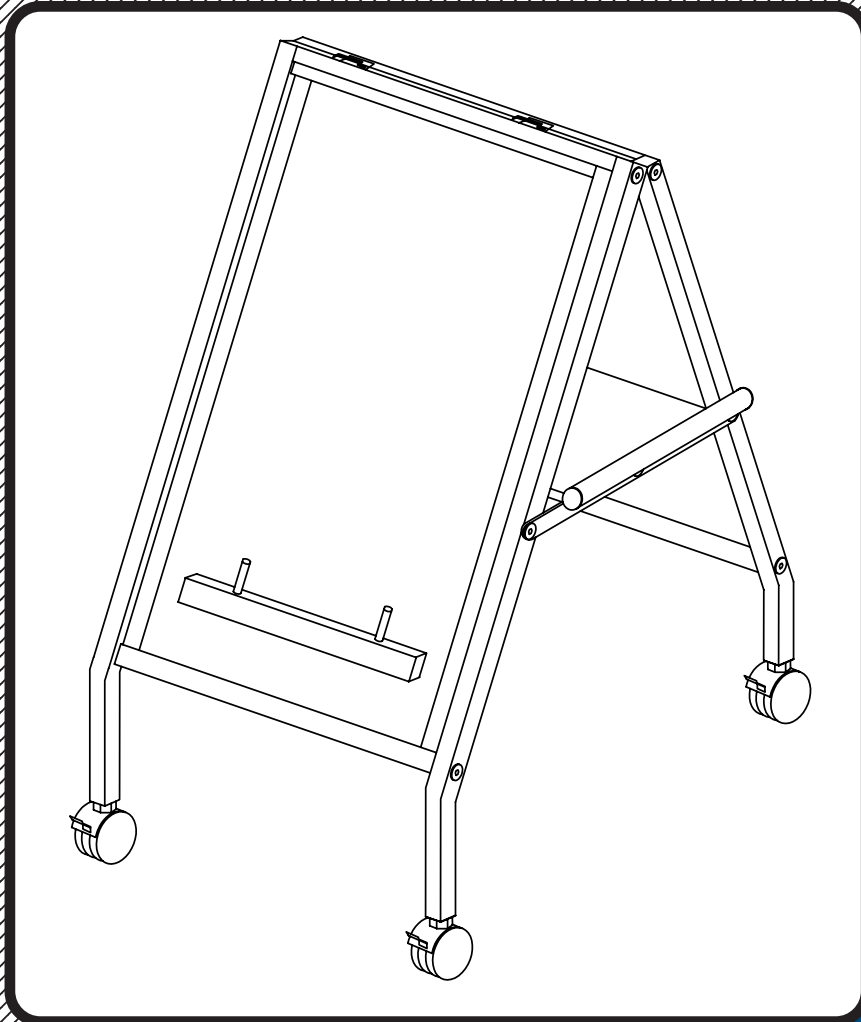

**Assembly Instructions**



# MFE on Wheels





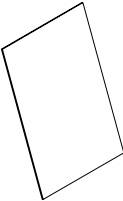
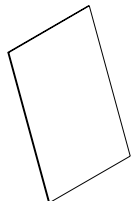

# Best-Rite

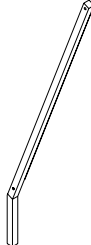
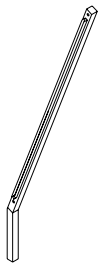
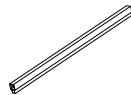
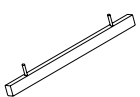
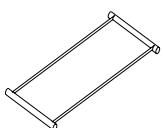
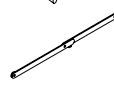
**"Its A Better Board"**

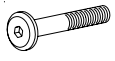
www.bestrite.com

## Hardware List

Part	Drawing	Description	Qty
P-1		Flannel Board	1 EA
P-2		White Board	1 EA
P-3		Top Cross Bar	1 EA
P-4		Right Leg	2 EA
P-5		Left Leg	2 EA
P-6		Bottom Cross Bar	2 EA
P-7		Big Book Holder	1 EA
P-8		Middle Tray	1 EA
P-9		Side Hinge	2 EA

A		1 1/2" Socket Screw	8 EA
B		1/2" Socket Screw	4 EA
C		Flat Washer	4 EA
D		2" Locking Caster	4 EA
E		Allen Wrench	1 EA
F		Caster Wrench	1 EA

**Should you require assistance during assembly, please call our Customer Service Department Monday - Friday 8 a.m. - 5 p.m. Central Standard Time Toll-Free Customer Service**  
**1-800-749-2258**

# MFE on Wheels Assembly Diagrams

READ THROUGH INSTRUCTIONS FROM BEGINNING TO END **BEFORE** STARTING TO ASSEMBLE UNIT.

## To Assemble:

1. Identify and Separate all the Parts and Hardware.
2. Attach Top Cross Bars (P-3) to Right Legs (P-4) and Left Legs (P-5) by using 1 1/2" Socket Screws (A). Make sure the Cross bar channels lines up with Leg channels. Tighten with Allen Wrench (F) as shown in illustration # 1.

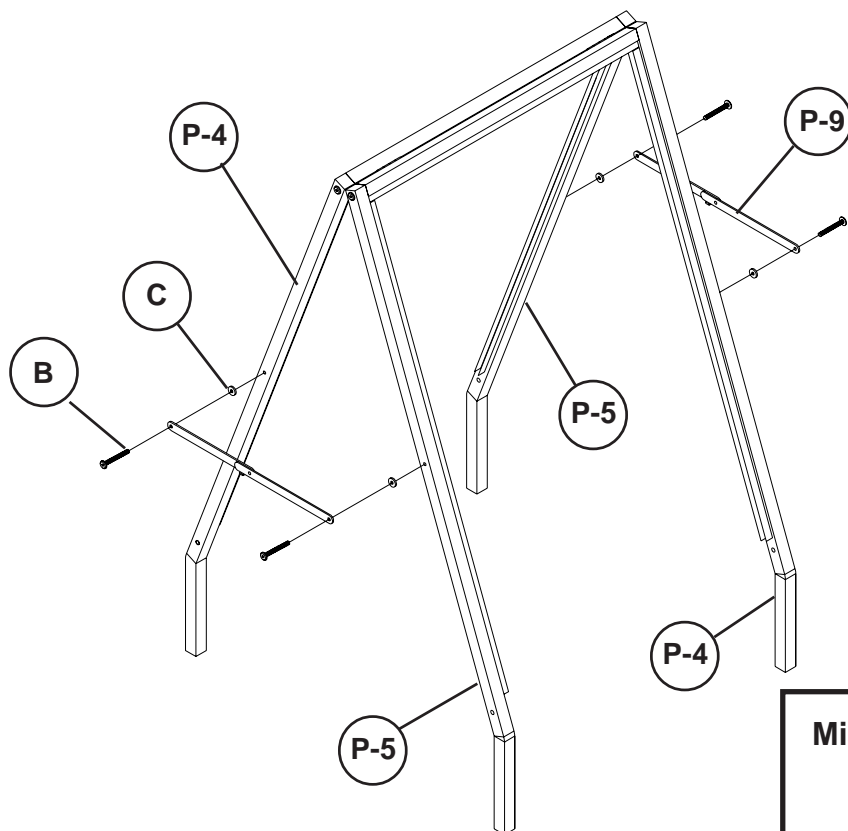
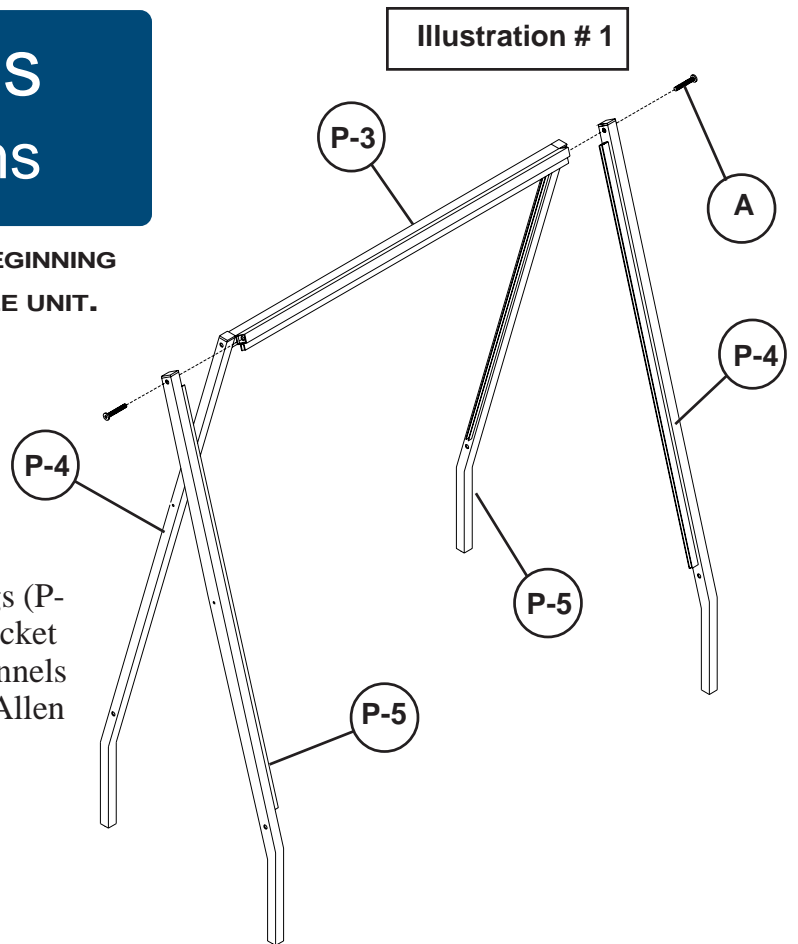

3. Insert Side Hinges (P-9) by using 1/2" Socket Screws (B) place Flat Washers (C) between Side Hinges (P-9) on Left and Right Legs (P-4), (P-5) as shown in illustration # 2.

**Missing Parts or UPS Damaged Parts**  
For Your Convenience you can  
EMAIL us at  
**[boards@bestrite.com](mailto:boards@bestrite.com)**  
24HOURS 7 DAYS A WEEK

Illustration # 2

**Illustration # 3**

4. Slide Flannel Board (P-1) and White board (P-2) through the Right legs (P-4) and Left Legs (P-5) side Channels as shown in illustration # 3.

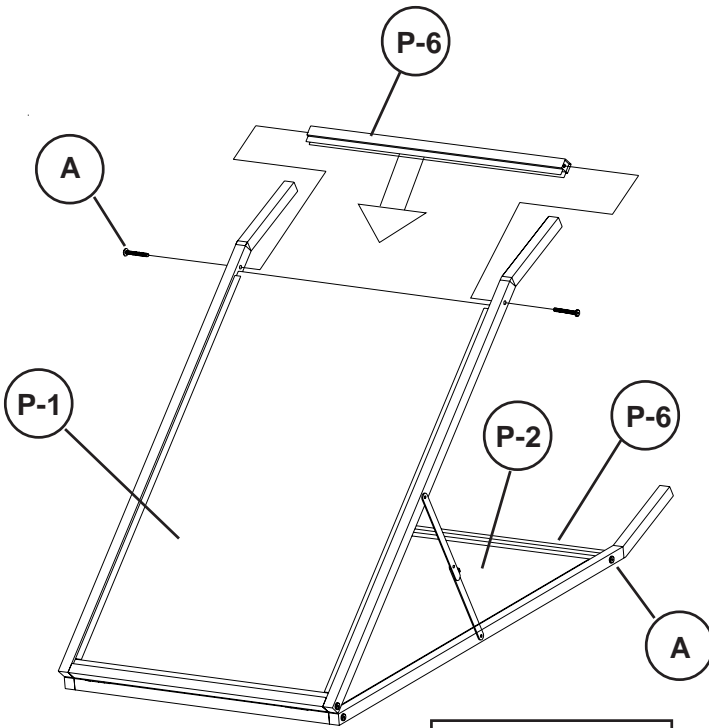
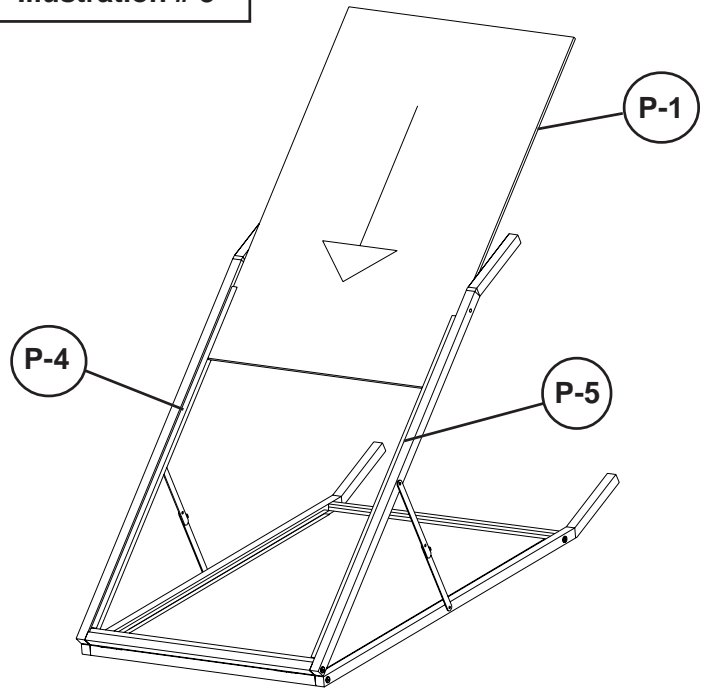

**Illustration # 4**

5. Insert the Bottom Cross Bars (P-6) over the Bottom of the Flannel Board (P-1) and White board (P-2) fasten by using Socket Screws (A). Tighten with Allen Wrench (F) as shown in illustration # 4.

6. Install 4-2" Locking Casters (D) on the bottom of legs. Tighten by using Caster Wrench (E) as shown in illustration # 5.

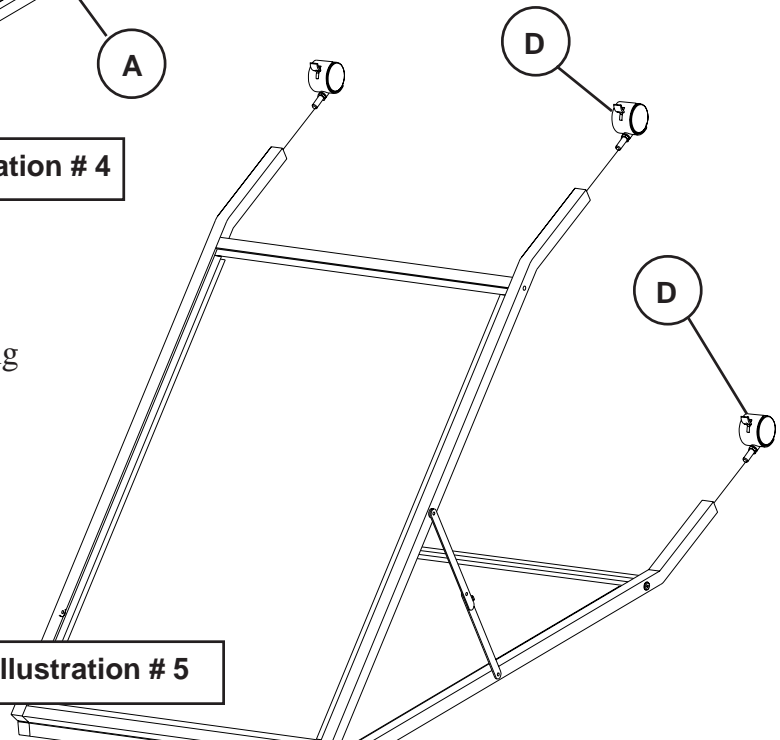

**Illustration # 5**

Do not use unless all screws are tight. At least every six months, check all screws to be sure they are tight. If parts are missing, broken, damaged, or worn, stop using the product until repairs are made by your dealer using factory authorized parts.

# MFE on Wheels

- Place Middle Tray (P-8) by tilting to one side then sliding it over the top of Side Hinges (P-9) and lay flat. To fold this unit you must remove the Middle Tray (P-8). Place Big Book Holder (P-7) over Magnetic Boards (P-1) or (P-2) as shown in illustration # 6.

