

USE WITH METAL AND CORRUGATED FLAT FILE DRAWERS

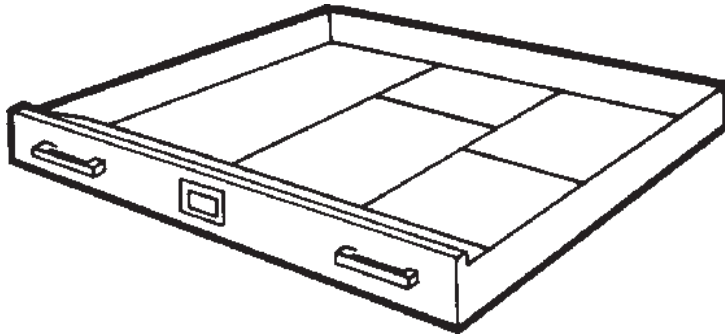

- 1** Use desired sheet size as guides.  
Draw light lines between them.

Caution: avoid placing dividers in path of paper holder.

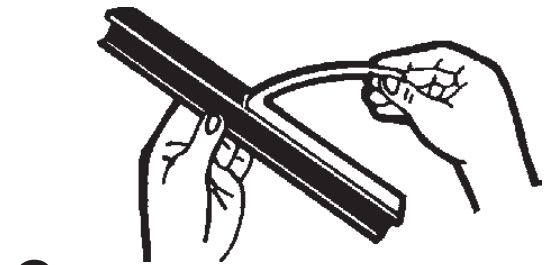
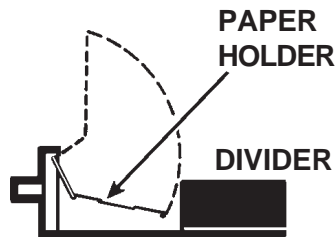

- 2** Peel off backing.

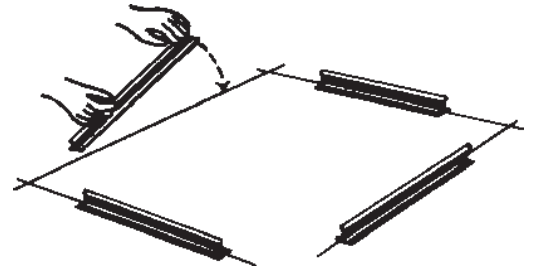

- 3** Align divider to line and press down.

UTILISER AVEC LES TIROIRS MÉTALLIQUES OU DE CARTON ONDULÉ DE CLASSEUR HORIZONTAL

- 1** Utiliser les feuilles de la grandeur voulue comme guides.  
Tracer des lignes minces entre les feuilles.

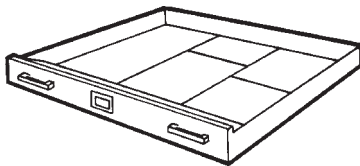

Attention : Ne pas mettre de séparateur dans l'espace où le serre-papiers se déplace.

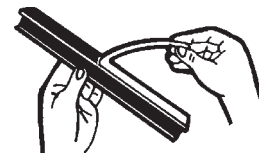
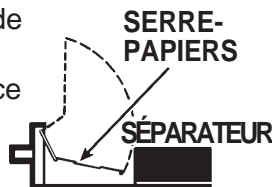

- 2** Enlever la bande protectrice.

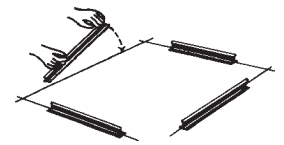

- 3** Aligner le séparateur sur la ligne, puis appuyer sur lui.

PARA USARSE CON CAJONES ACANALADOS Y DE METAL DEL ARCHIVADOR HORIZONTAL

- 1** Como guías, utilice hojas del mismo tamaño que las que desea archivar. Trace líneas débiles entre las hojas.

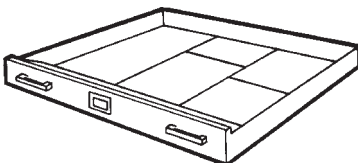

Precaución: No sitúae los separadores en la trayectoria del pisapapeles.

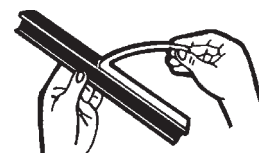
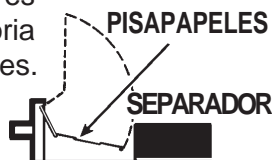

- 2** Desprenda el material protector.

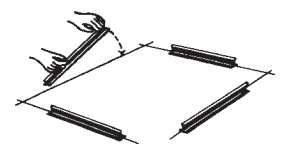

- 3** Alinee los separadores en las líneas que trazó y presione.